

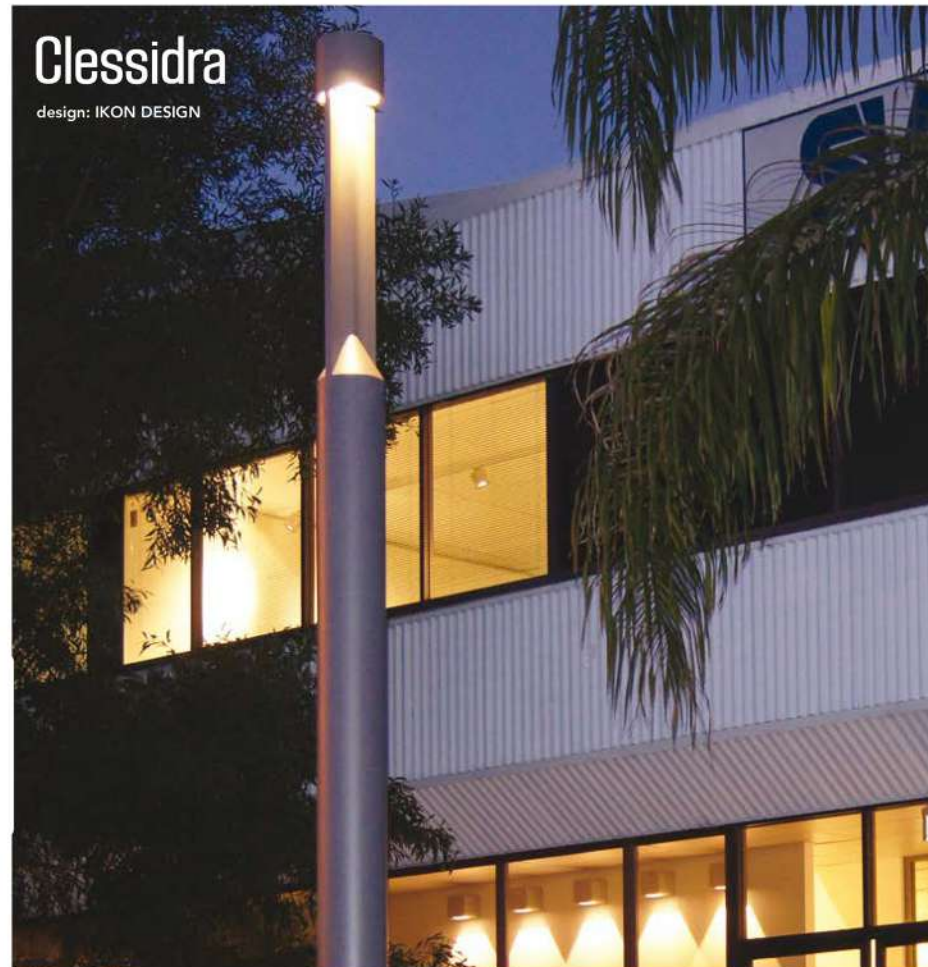

**BULLARD**  
BOLLARDS

# Clessidra



[g@gordonbullard.com](mailto:g@gordonbullard.com)  
[www.bullardbollards.com](http://www.bullardbollards.com)  
269-569-6700



991 South Gull Lake Dr  
Richland, MI 49083, USA  
1 877-964-464







**BULLARD**  
BOLLARDS

# Clessidra

CLESSIDRA concept is a design with minimal visual impact for the built and landscaped environments. The understand design together with the direct and ambient lighting elements make CLESSIDRA a sophisticated choice for use in city centres, parks, and prestigious architectural projects. CLESSIDRA allows a high degree of personalization for project specific versions.



CERTIFICATION	 
IP / IK RATING	IP 65
CLASSIFICATION	class I / II   class II upon request
DIMMABLE	dimnable DALI versione available upon request
BODY	cast aluminium EN AC 44100 high resistance to oxidation
COLUMN	structural ENGINEERING STEELS S235 JR (UNI EN 12219)
EXTERNAL FIXINGS	stainless steel A4-70 treated with highly antioxidant water-repellent lubricating solution. The treatment ensures easy opening of the product for maintenance
SEALING GASKET	silicone
LIGHT SOURCE	not included (Led integral)
FINISH	powder coating polyester high resistance to UV and oxidation

[g@gordonbullard.com](mailto:g@gordonbullard.com)  
[www.bullardbollards.com](http://www.bullardbollards.com)  
269-569-6700



991 South Gull Lake Dr  
Richland, MI 49083, USA  
1 877-964-464



# BULLARD BOLLARDS

## Clessidra

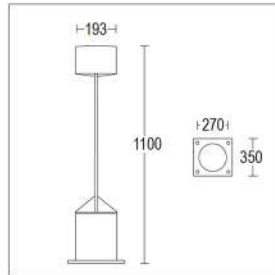

IP65



DALI upon request

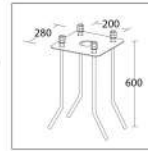

plated steel anchorage code

429

colour codes

- .05 anthracite grey
- .13 light grey

**1506.HAX.T.--** 26 W Led 3000 K 3600 lr  
**1506.HBX.T.--** 26 W Led 4000 K 3700 lr  
 220-240 V 50/60 HZ  
 microprismatic diffuser  
 led driver integral

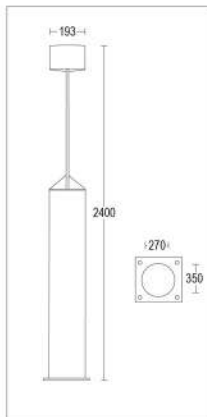
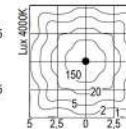
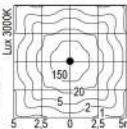
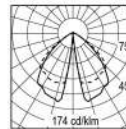
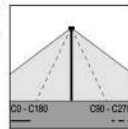

IP65



DALI upon request

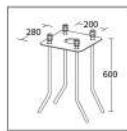

plated steel anchorage code

429

colour codes



**1507.HAX.T.--** 26 W Led 3000 K 3600 lm  
**1507.HBX.T.--** 26 W Led 4000 K 3700 lm  
 220-240 V 50/60 HZ  
 microprismatic diffuser  
 led driver integral

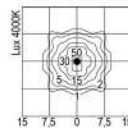
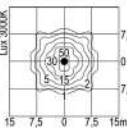
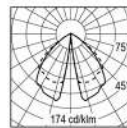
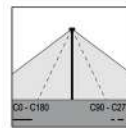

**1507.19X.T.--** 70 W G12 6600 lm  
 220-240 V 50/60 HZ  
 microprismatic diffuser  
 led driver integral

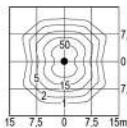
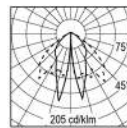
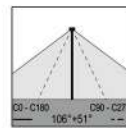

[g@gordonbullard.com](mailto:g@gordonbullard.com)  
[www.bullardbollards.com](http://www.bullardbollards.com)  
 269-569-6700



991 South Gull Lake Dr  
 Richland, MI 49083, USA  
 1 877-964-464



# BULLARD BOLLARDS

## Clessidra

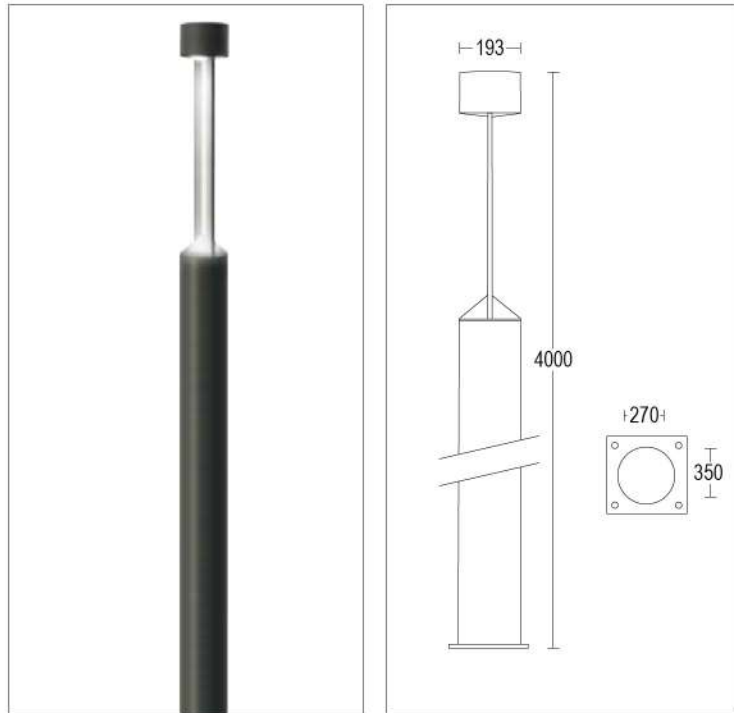

IP65  
DALI  
upon request

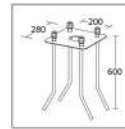

plated steel anchorage code

429

colour codes



**1501.HGX.T.--** 52 W Led 3000 K 7200 lm  
**1507.HHX.T.--** 52 W Led 4000 K 7400 lm  
220-240 V 50/60 HZ  
microprismatic diffuser  
led driver integral

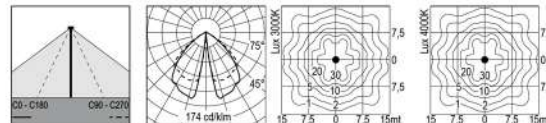

**1501.19X.T.--** 70 W HIT G12 6600 lm  
220-240 V 50/60 HZ  
microprismatic diffuser  
led driver integral

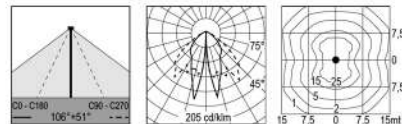

**1501.21X.T.--** 150 W HIT G12 6600 lm  
220-240 V 50/60 HZ  
microprismatic diffuser  
led driver integral

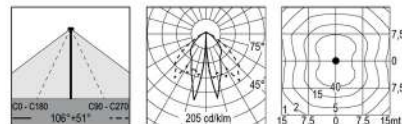

[g@gordonbullard.com](mailto:g@gordonbullard.com)  
[www.bullardbollards.com](http://www.bullardbollards.com)  
269-569-6700



991 South Gull Lake Dr  
Richland, MI 49083, USA  
1 877-964-464