

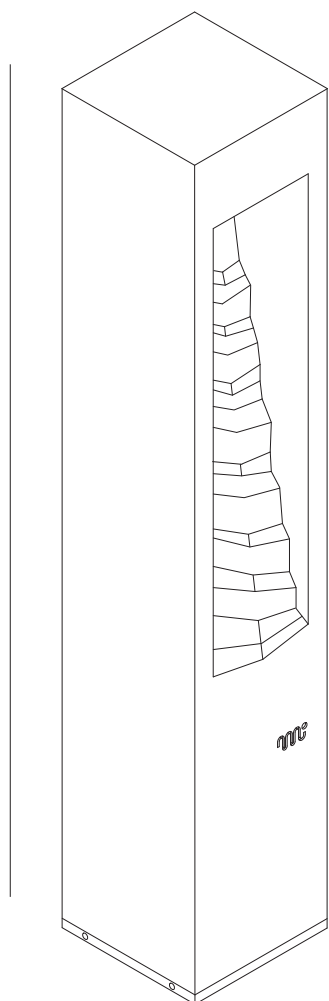

CRACK SQUARE



Square



710mm
27,95"

- 130x130mm
- 5,11" x 5,11"

BODY:

Available in raw cor-ten steel or artificially oxidised using an accelerated oxidation treatment. A process that under normal conditions changes an originally orange colour to a reddish-brown colour with tonal variations and nuances, as would occur over 18-36 months. Effects that can lead to the formation of different coloured oxides, giving variation in aesthetic characteristics, even between products. The formation of the oxidized surface layer, takes place only where atmospheric exposure and alternating wet and dry cycles are present. Otherwise the protective layer is not formed and the cor-ten steel behaves like a common steel. When introducing cor-ten, both raw and oxidised, oxide traces can be released that may stain the area surrounding the bollard.







LIGHT SOURCES:



9W LED. Available with WW (Warm White, 3000K) or NW (Neutral White, 4000K) CRI>80 colour temperature.

POWER SUPPLY:

Mains voltage power supply.

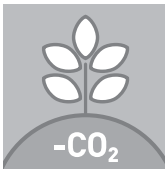
GENERAL INFORMATION:

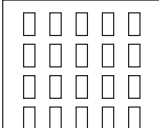

 IP65
 





 MID POWER LED
 
 Direct asymmetrical

CRACK SQUARE:

Light source	Wattage	kg	mm (H)	Code
LED	9W	8,20	710	76879. __ NW/WW
110-277V / 50-60Hz				
Ground prong kit				91190.00
NW (Neutral White):		CRI >80 / lm 640 / K 4000		
WW (Warm White):		CRI >80 / lm 630 / K 3000		

Integrated electronic control gear

Luminaire equipped with a pre-assembled power cable L=1m

COLOUR IDENTIFICATION TO BE ADDED TO THE CODE:



17
Oxidized Corten
 
46
Corten

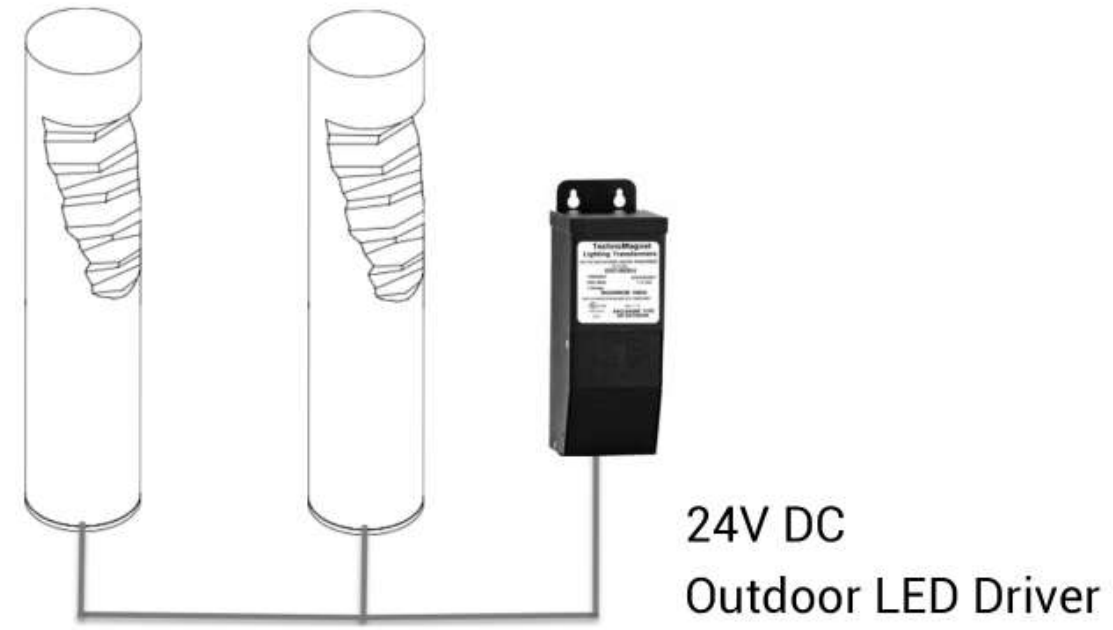

Installation details

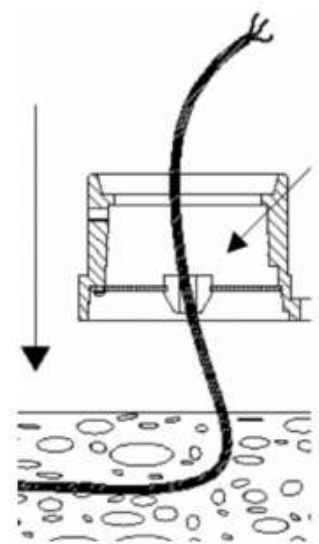

Run Low Voltage Wires



Screw down Fixture Base

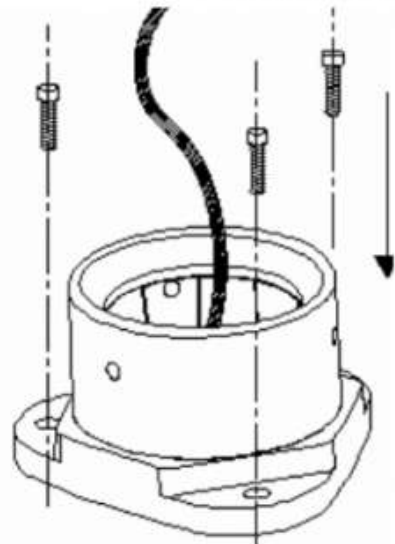

Slide fixture Body on top of base and Tighten

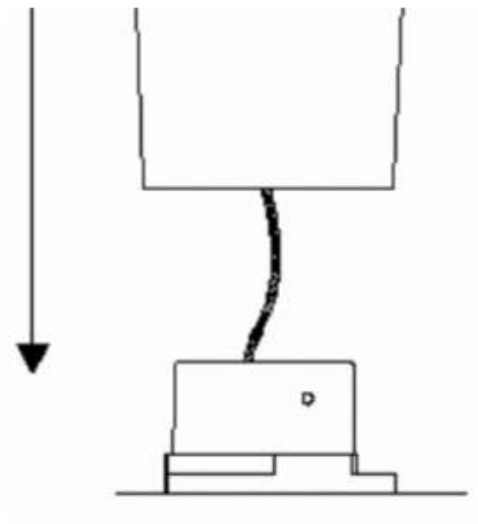

*actual product may vary during production process

