



PRODUCT CODE:

GH1506.CGXT300EN
1506.HAX.T

CONSTRUCTIVE & DIMENSIONAL:

Application field: Walkways and driveways, Passageways, Cycle paths, Gardens, Squares
 Construction material: Die-cast aluminum EN AB 44100 highly resistant to oxidation
 External screws: Stainless steel A4-70 treated with highly antioxidant water-repellent lubricating solution
 Diameter : 193mm (7,59")
 Height: 1100mm (43,30")

ELECTRICAL:

Description: 1 x 25.2 W LED 3000 K CRI>90 3100 lm
 Operating Power: 110-277 V / 50-60 Hz
 Number of heads: 1
 Number of Circuits: 1
 Driver positioning: Integral
 Control gear type: Electronic
 Cord length : 0.5m

Emergency kit: Not available

OPTICAL:

Beam type: Bollard [360° emission]
 Light distribution: Symmetric
 Beam directionability: Fixed
 Diffuser finish: Micro-prism

LIGHTING SOURCE:

Light source: LED
 Power: 25.2 W
 LED voltage range: 31.2-36.8V
 Current: 350 mA
 ZVEI - Led Type: COB
 Color temperature: 3000 K
 Binning: Step MacAdam 3
 Color rendering index: CRI>90
 Nominal LED emission: 3100 lm
 Light source: Included
 Ambient temperature operating range: -20 °C ÷ +35 °C

FINISH CODE:

 .05 Dark grey (matt)

 .19 Light Grey

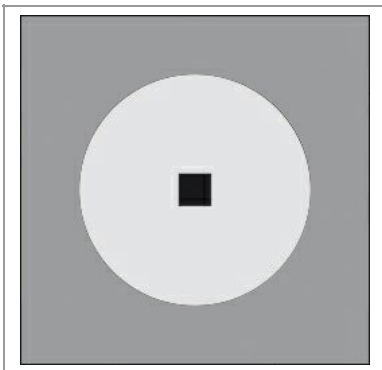
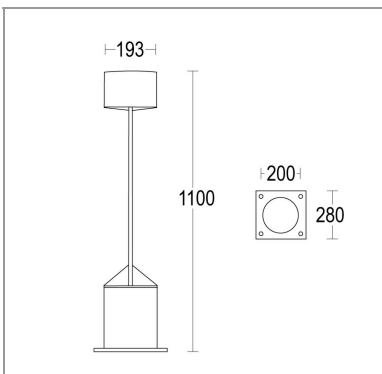

H(m)	φ(m)	Lux Medi
5	11.1	8
4	8.9	13
3	6.6	23
2	4.4	52
1	2.2	208



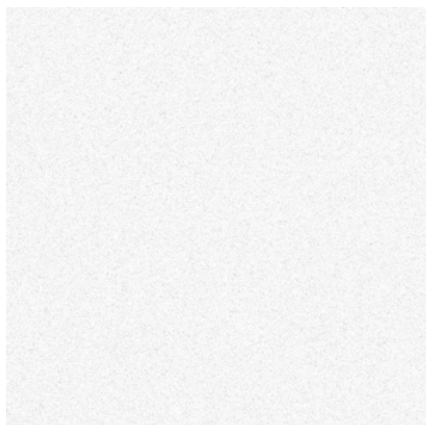

.01 WHITE



.05 ANTHRACITE GREY



.19 LIGHT GREY



.15 STAINLESS STEEL

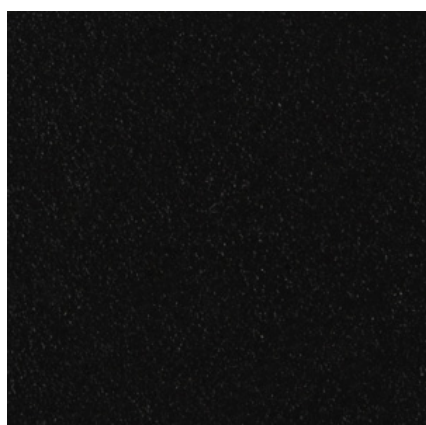

.02 BLACK



.32 OAK EFFECT



.45 RUST



.34 GLASS

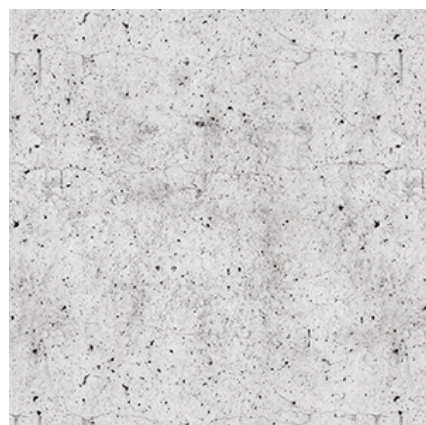

.43 CONCRETE EFFECT