



PRODUCT CODE:

GH1302.BRXO300EN

CONSTRUCTIVE & DIMENSIONAL:

| | |
|------------------------|--|
| Application field: | Walkways and driveways, Passageways, Cycle paths, Gardens |
| Construction material: | Anticorodal aluminum 6082, Extruded aluminum EN AW-6060 T5 high resistance to oxidation. |
| External screws: | Stainless steel A4-70 treated with highly antioxidant water-repellent lubricating solution |
| Diameter: | 147mm(5,78") |
| Width: | 28mm(1,10") |
| Height: | 900mm(35,43") |

ELECTRICAL:

| | |
|---------------------|--|
| Description: | 1 x 12 W LED 3000 K CRI>85 1300 lm |
| Operating Power: | 110-277 V / 50-60 Hz |
| Number of heads: | 1 |
| Number of Circuits: | 1 |
| Driver positioning: | Integral |
| Control gear type: | Electronic |
| Cable entry: | Fixture supplied with pre-wired cable H05RN-F 0.5m |
| Cord length: | 0,5m |



OPTICAL:

| | |
|----------------------------|-----------------------------|
| Beam type: | Bollard [360° emission] |
| Light distribution: | Light distribution diffused |
| Beam directionability: | Fixed |
| Diffuser material: | Polycarbonate |
| Diffuser finish: | Opal |
| Diffuser temperature [°C]: | < 35 °C / 95 °F |



LIGHTING SOURCE:

| | |
|--------------------------------------|-----------------|
| Light source: | LED |
| Power: | 12 W |
| ZVEI - Led Type: | DOB |
| Color temperature: | 3000K |
| Color rendering index: | CRI>85 |
| Nominal LED emission: | 1300lm |
| Light source: | Included |
| Ambient temperature operating range: | -20 °C ÷ +35 °C |

FINISH CODE:

| | | |
|--|--|--|
|  .01 White (matt) |  .05 Dark grey (matt) |  .19 Light Grey |
|--|--|--|

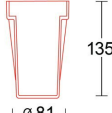
ACCESSORIES:

| | | |
|---|---|---|
|  |  |  |
| Stake 220mm AC711 | Rough-in housing x Pole AC447 | IP 68 fast connector Small AC204 |

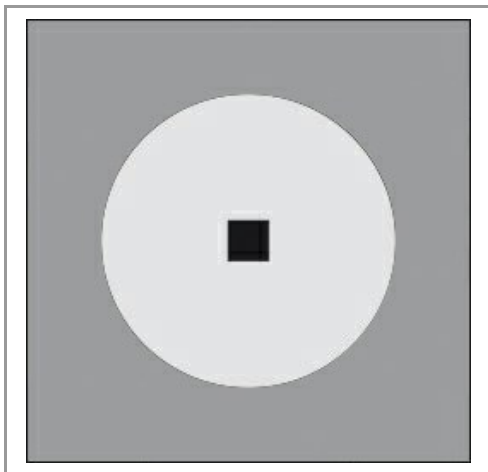
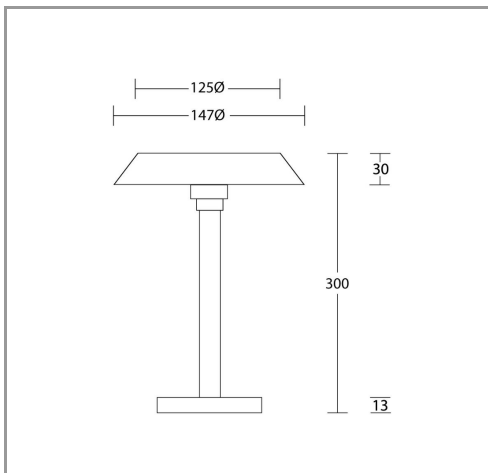

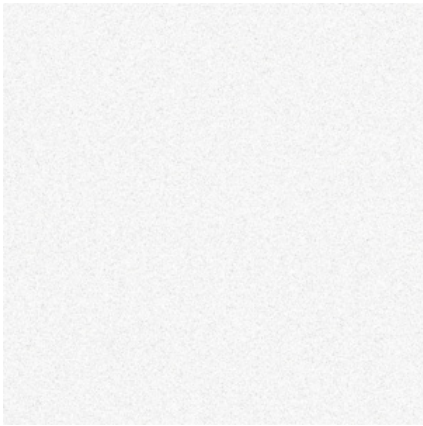

.01 WHITE



.05 ANTHRACITE GREY



.19 LIGHT GREY

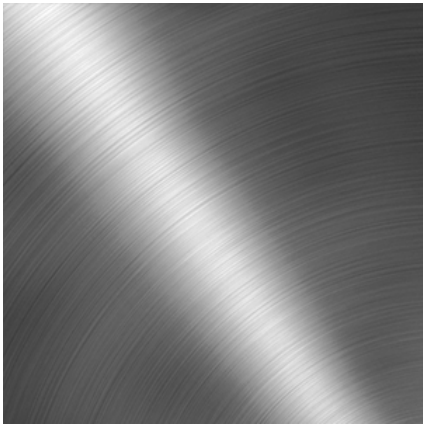

.15 STAINLESS STEEL

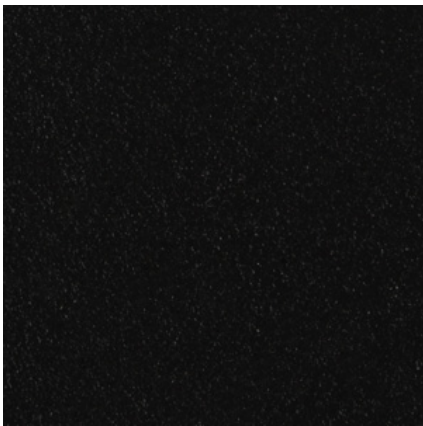

.02 BLACK



.32 OAK EFFECT



.45 RUST



.34 GLASS



.43 CONCRETE EFFECT