



PRODUCT CODE:

GH1305.AHXO300EN

CONSTRUCTIVE & DIMENSIONAL:

Application field:	Walkways and driveways, Passageways, Cycle paths, Gardens
Construction material:	Anticorodal aluminum 6082, Extruded aluminum EN AW-6060 T5 high resistance to oxidation.
External screws:	Stainless steel A4-70 treated with highly antioxidant water-repellent lubricating solution
Diameter:	105mm(4,13")
Width:	28mm(1,10")
Height:	250mm(9,84")

ELECTRICAL:

Description:	1 x 7 W LED 3000 K CRI>85 900 lm
Operating Power:	110-277 V / 50-60 Hz
Number of heads:	1
Number of Circuits:	1
Driver positioning:	Integral
Control gear type:	Electronic
Cable entry:	Fixture supplied with pre-wired cable H05RN-F 0.5m
Cord length:	0,5m



OPTICAL:

Beam type:	Bollard [360° emission]
Light distribution:	Light distribution diffused
Beam directionability:	Fixed
Diffuser material:	Polycarbonate
Diffuser finish:	Opal
Diffuser temperature [°C]:	< 35 °C / 95 °F



LIGHTING SOURCE:

Light source:	LED
Power:	7 W
ZVEI - Led Type:	DOB
Color temperature:	3000K
Color rendering index:	CRI>85
Nominal LED emission:	900lm
Light source:	Included
Ambient temperature operating range:	-20 °C ÷ +35 °C

FINISH CODE:

 .01 White (matt)	 .05 Dark grey (matt)	 .19 Light Grey
--	--	--

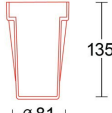
ACCESSORIES:

		
Stake 220mm AC711	Rough-in housing x Pole AC447	IP 68 fast connector Small AC204

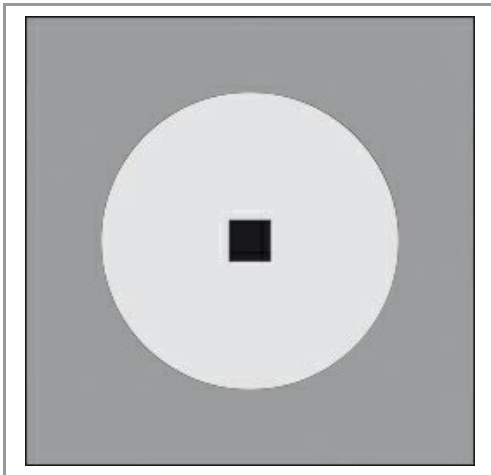
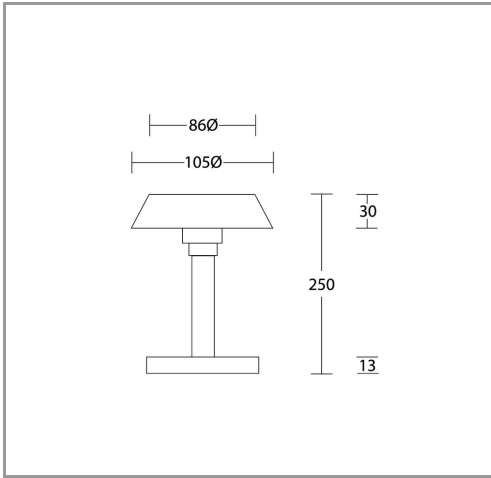

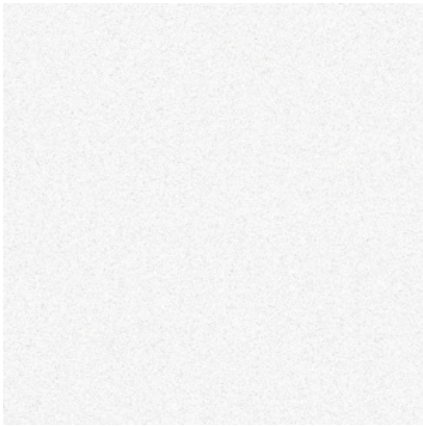

.01 WHITE

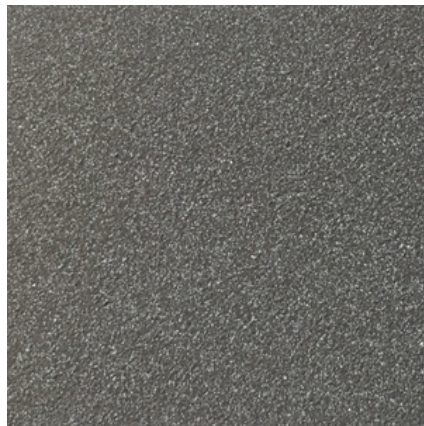

.05 ANTHRACITE GREY



.19 LIGHT GREY

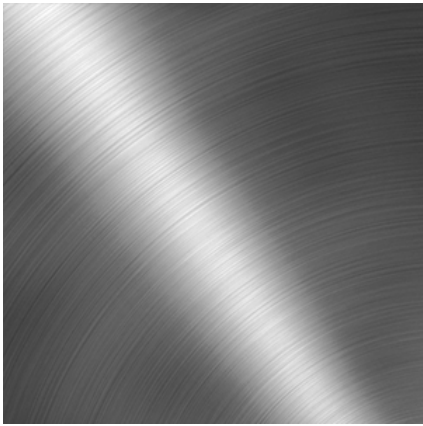

.15 STAINLESS STEEL

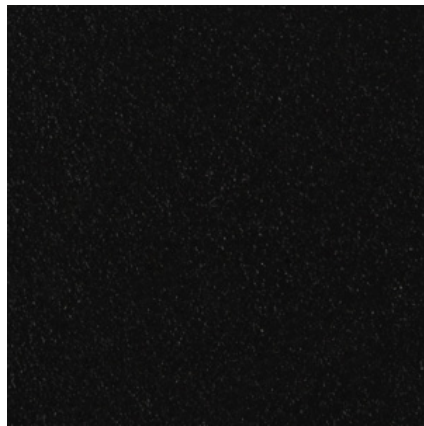

.02 BLACK



.32 OAK EFFECT



.45 RUST



.34 GLASS



.43 CONCRETE EFFECT