



## PRODUCT CODE:

GH1306.AHXO300EN

## CONSTRUCTIVE & DIMENSIONAL:

Application field:	Walkways and driveways, Passageways, Cycle paths, Gardens
Construction material:	Anticorodal aluminum 6082, Extruded aluminum EN AW-6060 T5 high resistance to oxidation.
External screws:	Stainless steel A4-70 treated with highly antioxidant water-repellent lubricating solution
Diameter:	105mm(4,13")
Width:	28mm(1,10")
Height:	500mm(19,68")

## ELECTRICAL:

Description:	1 x 7 W LED 3000 K CRI>85 900 lm
Operating Power:	110-277 V / 50-60 Hz
Number of heads:	1
Number of Circuits:	1
Driver positioning:	Integral
Control gear type:	Electronic
Cable entry:	Fixture supplied with pre-wired cable H05RN-F 0.5m
Cord length:	0,5m



## OPTICAL:

Beam type:	Bollard [360° emission]
Light distribution:	Light distribution diffused
Beam directionability:	Fixed
Diffuser material:	Polycarbonate
Diffuser finish:	Opal
Diffuser temperature [°C]:	< 35 °C / 95 °F



## LIGHTING SOURCE:

Light source:	LED
Power:	7 W
ZVEI - Led Type:	DOB
Color temperature:	3000K
Color rendering index:	CRI>85
Nominal LED emission:	900lm
Light source:	Included
Ambient temperature operating range:	-20 °C ÷ +35 °C

## FINISH CODE:

 .01 White (matt)	 .05 Dark grey (matt)	 .19 Light Grey
--	--	--

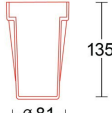
## ACCESSORIES:

		
Stake 220mm AC711	Rough-in housing x Pole AC447	IP 68 fast connector Small AC204

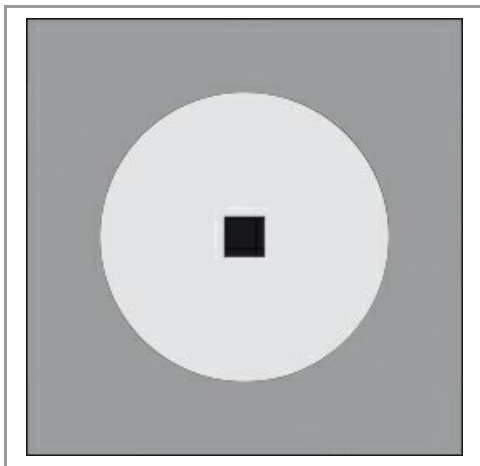
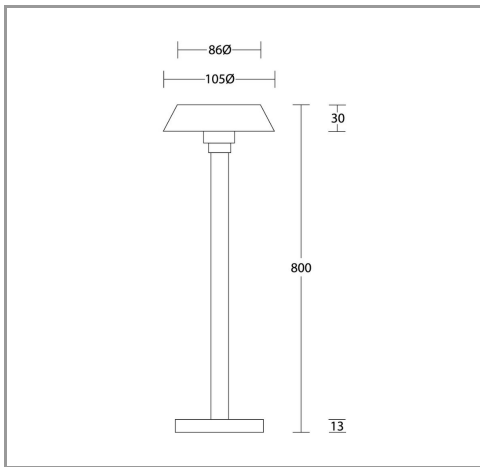

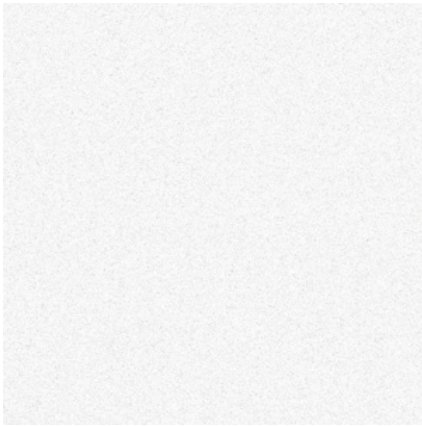

**.01 WHITE**



**.05 ANTHRACITE GREY**



**.19 LIGHT GREY**



**.15 STAINLESS STEEL**

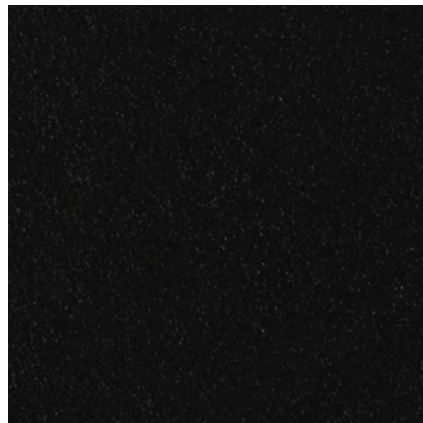

**.02 BLACK**



**.32 OAK EFFECT**



**.45 RUST**



**.34 GLASS**

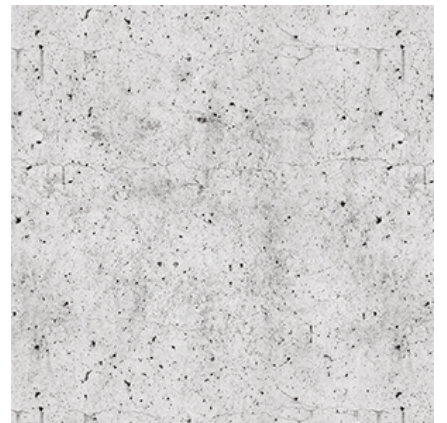

**.43 CONCRETE EFFECT**