

Floor lamp  
 Year of production: 2004  
 Versions: lighting.  
 Material: Polyethylene.  
 Cable color: Black  
 Dimensions: Ø 200 cm(78.74")  
 Weight: 93 Kg  
 Packaging: 202 x 202 x 249 cm  
 Packaging volume: 10,16 m3  
 Note: no box packaging.



|                 |   |  |  |
|-----------------|---|--|--|
| DIMENSIONS (cm) |   |  |  |
| CODE            | LP SFF200<br>lighting OUT   |  |  |
| LIGHTING        | 1x<br>Note: earth spike included  |  |  |
|                 | for additional mounting option see page 10*                                     |  |  |
| COLOURS         | LIGHTING<br><input type="radio"/> LIGHT WHITE (code LA)<br><u>GLOSSY FINISH</u> |  |  |

WE WELCOME ALL CUSTOM ORDERS!

IES files upon Request

sales@gordonbullard.com

www.bullardbollards.com

1-877-964-4646



991 South Gull Lake Dr

Richland, MI 49083

US USA

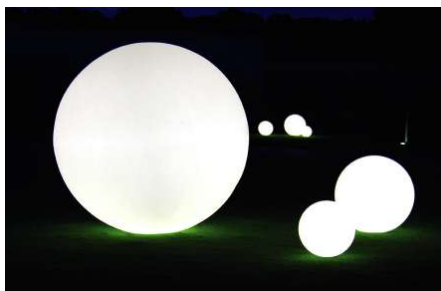
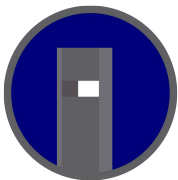

DIMENSIONS (cm) - CODE - COLOURS

### EARTH SPIKE

Material: steel silver.  
Weight: 0,5 Kg  
Note: included.

### LP PIC003

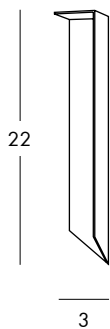

### TRACK FOR EARTH SPIKE

Material: steel silver.  
Weight: 0,5 Kg  
Note: not included.

### LP TUB001

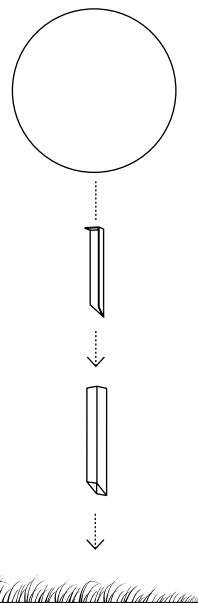
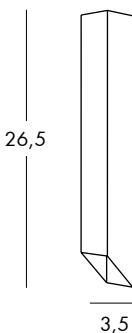

### EARTH SPIKE

Material: steel silver.  
Weight: 0,1 Kg  
Note: not included.

### LP TUB002

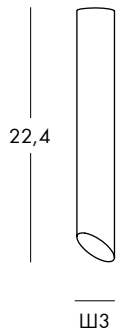

### METAL RING (for Globo 60, 70, 80)

Material: steel silver.  
Weight: 0,8 Kg  
Note: not included.

### LP RIN300

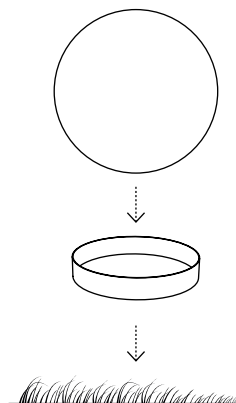
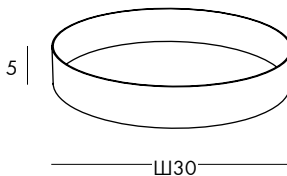

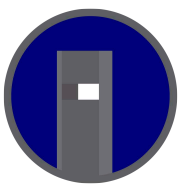

## ADDITIONAL MOUNTING OPTIONS

**.KB Cement anchor bolts**

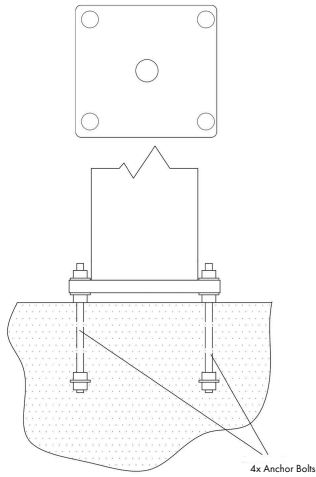

**.OG Ground stake**

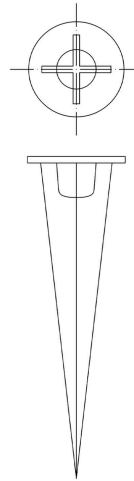

**.AF Plate with screws**

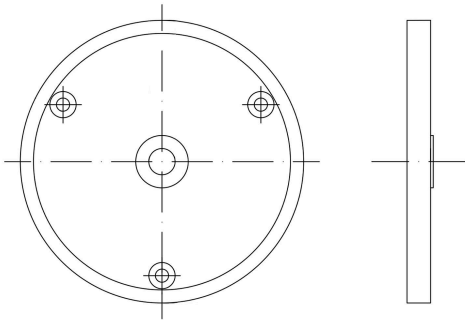

**.QR Pole mounting +(one of 3 other options)**

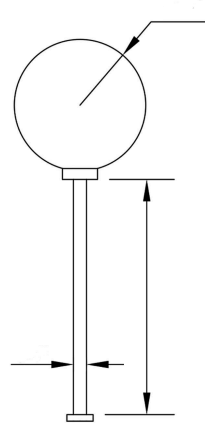







pipe diameter 3" for GLOBO:  
30CM/40/60CM/80CM

pipe diameter 6" for GLOBO:  
120CM/200CM





















Note\*: Custom Sizes of Pole on request starting from 3 inches





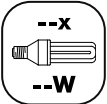

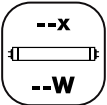
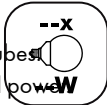

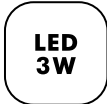

## SYMBOLS

-  For indoor use.
-  Stackable item.
-  For indoor and outdoor use.
-  100% recyclable polyethylene.
-  Recycling and disposal of electronic waste (WEEE).
-  Outdoor version on request (R55).

## LIGHTING SYMBOLS

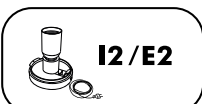
-  Protected against the intrusion of solid objects  $\geq 12$  mm, not against water.
  -  RGB lighting system.
  -  Protected against the intrusion of solid objects  $\geq 1$  mm and splashing water.
  -  Lamp base for G4 halogen bulb.
  -  Item compatible with Candy Light.
  -  Protected against the intrusion of dust and water jets.
  -  Lamp base for GU10 spotlight.
  -  Insulation class 1.
  -  Fully protected against the intrusion of dust and immersion in water.
  -  Lamp base for G13 neon tube.
  -  Insulation class 2.
  -  Small lamp base for E14 - 14 mm light bulb.
  -  tube lighting system.
  -  Insulation class 3.
  -  Medium lamp base for E26 - 26 mm light bulb.
  -  LED technology lighting system.
  -  Device proper to direct assembly onto normally inflammable surfaces.
- 
-  Lighting through energy saving bulb. The upper figure shows the number of allowed bulbs. The lower figure shows the MAXIMUM recommended power.
  -  Lighting through energy saving fluorescent spotlight. The upper figure shows the number of allowed spotlights. The lower figure shows the MAXIMUM recommended power.
  -  Lighting through neon tube. The upper figure shows the number of allowed neon tubes. The lower figure shows the MAXIMUM recommended power.
  -  Lighting through energy saving globe bulb. The upper figure shows the number of allowed bulbs. The lower figure shows the MAXIMUM recommended power.
  -  Lighting through flexible LED tube. The upper figure shows the number of allowed LED tubes. The lower figure shows the MAXIMUM recommended power.
  -  Lighting through circular T9 neon tube. The upper figure shows the number of allowed neon tubes. The lower figure shows the MAXIMUM recommended power.

## WIRING SYMBOLS

-  Wiring with metal clamp. IP20 protection. Diameter 11 cm.
-  Wiring with special base for KIT LED 3 WATT. IP55 protection. Diameter 11,6 cm.
-  Wiring with metal base. IP55 protection. Diameter 10 cm. Fastening by hex screw key.
-  Wiring with plastic screw base. I3 - IP20 protection. E3 - IP55 protection. Diameter 6 cm.
-  Wiring with metal base. IP55 protection. Diameter 20 cm. Fastening by hex screw key.
-  Wiring with plastic screw base. I3 - IP20 protection. E3 - IP55 protection. Diameter 10 cm.
-  Wiring with plastic base and metal inserts. I2 - IP20 protection. E2 - IP55 protection. Diameter 10 cm. Fastening by slot screwdriver.
-  Wiring with plastic screw base. I3 - IP20 protection. E3 - IP55 protection. Diameter 15 cm.
-  Wiring with plastic base and LED CANDY LIGHT. IP44 protection. Diameter 10 cm.
-  Special metal base. IP20 protection. Several sizes.

## MATERIAL PROPERTIES

---

Material: Linear low-density polyethylene - LLDPE.  
Production process: rotational moulding.  
Resistant to extreme temperatures (-60°C to +80°C).  
UV resistant (except for lighting colours).  
High tensile strength.

## WARNING

---

- Keep away from excessive heat sources.
- Avoid any improper use. Do not stand on the products. When the product has to be moved, lift the product off the ground in order to avoid damage.
- Do not overload the pot structure in order to avoid deforming.
- Carefully comply with the maintenance & cleaning instructions.
- In case of malfunctioning or damage of the wiring or any electrical parts, refer to a qualified electrician.

## MAINTENANCE & CLEANING

---

- To prevent dust and dirt from sticking to the plastic surfaces, periodically clean the products with a damp cloth and neutral liquid soap diluted in water.
- Avoid using ethanol or any liquids containing, even in small amounts, acetone, trichloroethylene or ammonia (solvents in general).
- The lacquered version is also suitable for outdoor use, however it is more sensitive to scratches: periodically clean with a polish cleaner, gently rubbing with soft cloth/cotton wool.
- Cushions can be cleaned with a damp cloth, neutral liquid soap and water.
- For metal parts use specific cleaners.

**WE WELCOME ALL CUSTOM ORDERS!**  
**IES files upon Request**

---

sales@gordonbullard.com  
www.bullardbollards.com  
1-877-964-4646



991 South Gull Lake Dr  
Richland, MI 49083  
USA

---

Due to the dynamic nature of lighting products and the associated technologies, luminaire data on all sheet sheets is subject to change at the discretion of Gordon Bullard LLC and associated companies.