

Floor lamp
 Year of production: 2001
 Versions: lighting.
 Material: Polyethylene.
 Cable color: Black
 Dimensions: Ø 50 cm(19.68")
 Weight: 3,5 Kg
 Packaging: 51 x 51 x 51 cm
 Packaging volume: 0,133 m3



DIMENSIONS (cm)			
	LP SFF050 lighting OUT	LP SFF052 lighting OUT	LB SFE050 lighting LED
LIGHTING	1x IP55* * Note: earth spike included	1x E3/13 MEDIUM Note: earth spike on demand	CANDY LIGHT KIT LED 3W RGB MULTICOLOUR (included). With battery charger and remote control (battery life 8hrs - charging time 10 hrs).
	for additional mounting option see page 10*		Energy saving bulb recommended (not included).
COLOURS	LIGHTING ○ LIGHT WHITE (code LA) <u>GLOSSY FINISH</u>	LIGHTING ○ LIGHT WHITE (code LA) <u>MATT FINISH</u>	LED VERSION ○ LIGHT WHITE (code LA) <u>MATT FINISH</u>

WE WELCOME ALL CUSTOM ORDERS!

IES files upon Request

sales@gordonbullard.com
 www.bullardbollards.com
 1-877-964-4646



991 South Gull Lake Dr
 Richland, MI 49083
 US USA

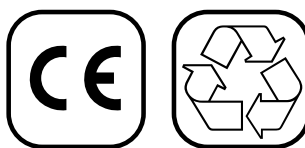
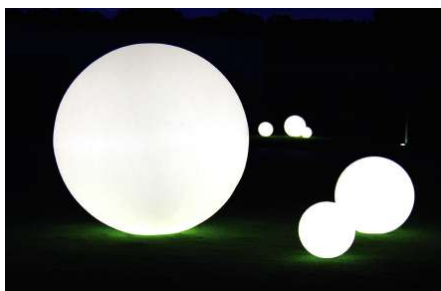
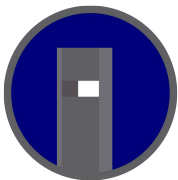

DIMENSIONS (cm) - CODE - COLOURS

EARTH SPIKE

Material: steel silver.
Weight: 0,5 Kg
Note: included.

LP PIC003

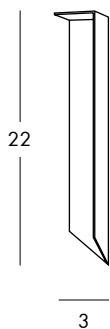

TRACK FOR EARTH SPIKE

Material: steel silver.
Weight: 0,5 Kg
Note: not included.

LP TUB001

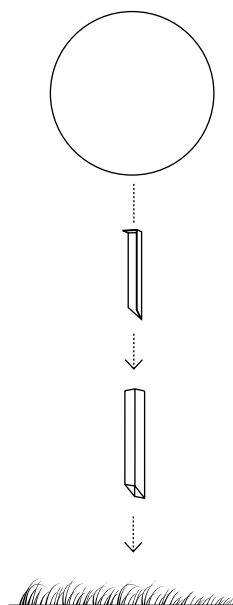
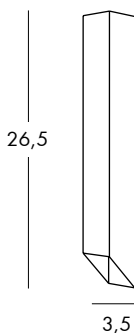

EARTH SPIKE

Material: steel silver.
Weight: 0,1 Kg
Note: not included.

LP TUB002

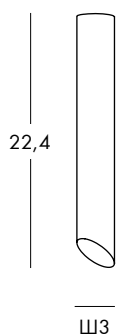

METAL RING (for Globo 60, 70, 80)

Material: steel silver.
Weight: 0,8 Kg
Note: not included.

LP RIN300

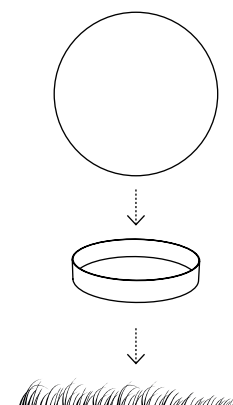
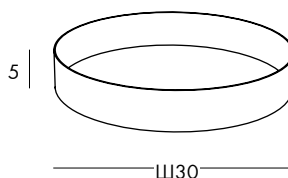

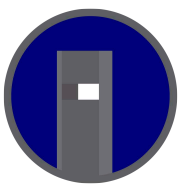

ADDITIONAL MOUNTING OPTIONS

.KB Cement anchor bolts

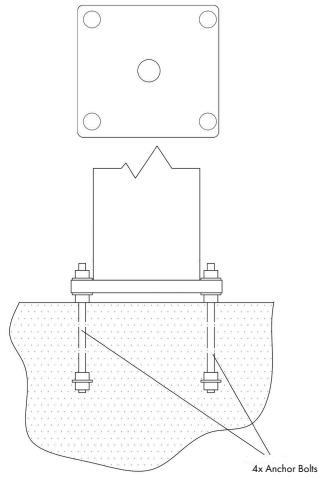

.OG Ground stake

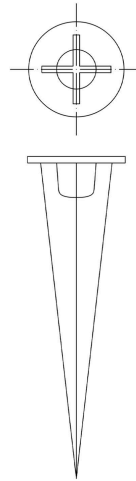

.AF Plate with screws

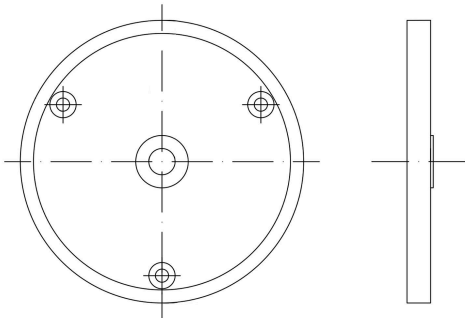

.QR Pole mounting +(one of 3 other options)

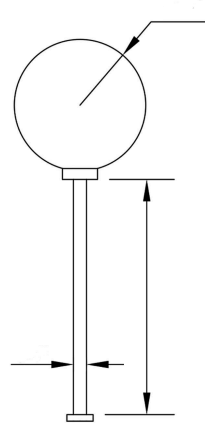

pipe diameter 3" for
GLOBO:
30CM/40/60CM/
80CM

pipe diameter 6" for
GLOBO:
120CM/200CM

Note*: Custom Sizes of Pole on request starting from 3 inches

**WE WELCOME ALL CUSTOM ORDERS!
IES files upon Request**

SYMBOLS



For indoor use.



Stackable item.



For indoor and outdoor use.



100% recyclable polyethylene.



Recycling and disposal of electronic waste (WEEE).



Outdoor version on retracts (R/S)

LIGHTING SYMBOLS



Protected against the intrusion of solid objects ≥ 12 mm, not against water.



RGB lighting system.



Protected against the intrusion of solid objects ≥ 1 mm and splashing water.



Lamp base for G4 halogen bulb.



Item compatible with Candy Light.



Protected against the intrusion of dust and water jets.



Lamp base for GU10 spotlight.



Insulation class 1.



Fully protected against the intrusion of dust and immersion in water.



Lamp base for G13 neon tube.



Insulation class 2.



Small lamp base for E14 - 14 mm light bulb.



tube lighting system.



Insulation class 3.



Medium lamp base for E26 - 26 mm light bulb.



LED technology lighting system.



Device proper to direct assembly onto normally inflammable surfaces.

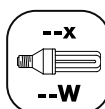

Lighting through energy saving bulb.
The upper figure shows the number of allowed bulbs.
The lower figure shows the MAXIMUM recommended power.

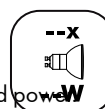

Lighting through energy saving fluorescent spotlight.
The upper figure shows the number of allowed spotlights.
The lower figure shows the MAXIMUM recommended power.

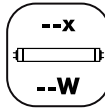

Lighting through neon tube.
The upper figure shows the number of allowed neon tubes.
The lower figure shows the MAXIMUM recommended power.

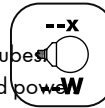

Lighting through energy saving globe bulb.
The upper figure shows the number of allowed bulbs.
The lower figure shows the MAXIMUM recommended power.



Lighting through flexible LED tube.
The lower figure shows the MAXIMUM recommended power.



Lighting through circular T9 neon tube.
The upper figure shows the number of allowed neon tubes.
The lower figure shows the MAXIMUM recommended power.

WIRING SYMBOLS



Wiring with metal clamp.
IP20 protection.
Diameter 11 cm.

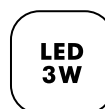

Wiring with special base for KIT LED 3 WATT.
IP55 protection.
Diameter 11,6 cm.



Wiring with metal base.
IP55 protection.
Diameter 10 cm. Fastening by hex screw key.



Wiring with plastic screw base.
I3 - IP20 protection. E3 - IP55 protection.
Diameter 6 cm.



Wiring with metal base.
IP55 protection.
Diameter 20 cm. Fastening by hex screw key.



Wiring with plastic screw base.
I3 - IP20 protection. E3 - IP55 protection.
Diameter 10 cm.

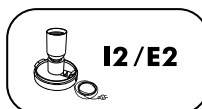

Wiring with plastic base and metal inserts.
I2 - IP20 protection. E2 - IP55 protection.
Diameter 10 cm. Fastening by slot screwdriver.

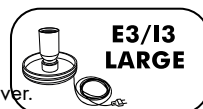

Wiring with plastic screw base.
I3 - IP20 protection. E3 - IP55 protection.
Diameter 15 cm.



Wiring with plastic base and LED CANDY LIGHT.
IP44 protection.
Diameter 10 cm.



Special metal base.
IP20 protection.
Several sizes.

MATERIAL PROPERTIES

Material: Linear low-density polyethylene - LLDPE.
Production process: rotational moulding.
Resistant to extreme temperatures (-60°C to +80°C).
UV resistant (except for lighting colours).
High tensile strength.

WARNING

- Keep away from excessive heat sources.
- Avoid any improper use. Do not stand on the products. When the product has to be moved, lift the product off the ground in order to avoid damage.
- Do not overload the pot structure in order to avoid deforming.
- Carefully comply with the maintenance & cleaning instructions.
- In case of malfunctioning or damage of the wiring or any electrical parts, refer to a qualified electrician.

MAINTENANCE & CLEANING

- To prevent dust and dirt from sticking to the plastic surfaces, periodically clean the products with a damp cloth and neutral liquid soap diluted in water.
- Avoid using ethanol or any liquids containing, even in small amounts, acetone, trichloroethylene or ammonia (solvents in general).
- The lacquered version is also suitable for outdoor use, however it is more sensitive to scratches: periodically clean with a polish cleaner, gently rubbing with soft cloth/cotton wool.
- Cushions can be cleaned with a damp cloth, neutral liquid soap and water.
- For metal parts use specific cleaners.

sales@gordonbullard.com
www.bullardbollards.com
1-877-964-4646



991 South Gull Lake Dr
Richland, MI 49083
USA