

CONSTRUCTIVE DIMENSIONAL:

Application field:	Series of recessed lighting fixtures characterized by the reduced recess depth of only 50mm.
Construction material:	Die-cast aluminum EN AB 44100 highly resistant to oxidation
External screws:	Stainless steel A4-70 treated with highly antioxidant waterrepellent lubricating solution
Gaskets:	Silicone gaskets
Diameter [mm]:	140mm(5,51")
Height / Projection [mm]:	26mm(1,02")
Cutout shape:	Round
Cutout diameter [mm]:	143mm(5,62")
Recessed depth [mm]:	57mm(2,24")
Rough in housing:	Stainless steel AISI 430 - to be ordered separately

ELECTRICAL:

Description and Model Code:	GH1360.BGXP300EN	1 x 4 W LED 3000 K CRI>90	1 x 544 lm
	GH1360.BGXP400EN	1 x 4 W LED 4000 K CRI>90	1 x 576 lm
		110-277 V / 50-60 Hz	
Operating Power:	1		
Number of heads:	1		
Number of circuits:	Integral		
Driver positioning:	24.01 for model GH1360.BGXP300EN		
Luminaire efficiency [lm/W]:	25.42 for model GH1360.BGXP400EN		
Fixture consumption:	5.33 W		
Control gear type:	Electronic		
Dimmer type:	Not dimmable		
Cable entry:	IP66 lamellar bushing Ø max 9mm		
Daisy chain wiring:	External to the luminaire with IP68 connector available as an accessory		
Emergency:	Not available		
Ambient temperature operating range [°C]:	-20 °C ÷ +35 °C		

OPTICAL:

Beam angle [°]	42° x 85°
Light distribution	Other
Beam directionability	Fixed optics
Diffuser material	Sodium-calcium tempered glass 3mm
Diffuser finish	Micro-prism
Diffuser temperature [°C]	< 30 °C / 86 °F

LIGHTING SOURCE for model GH1360.BGXP300EN



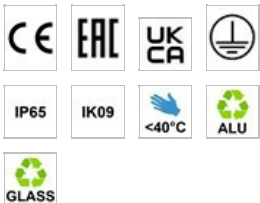
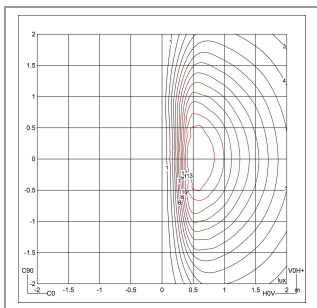
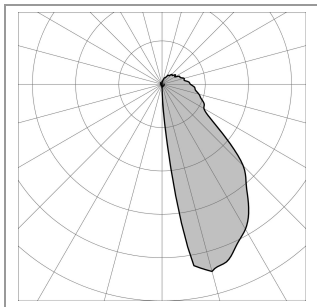
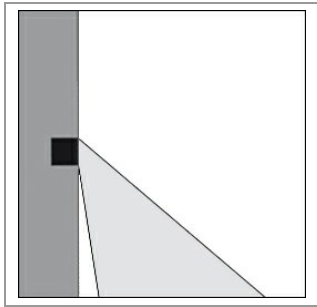
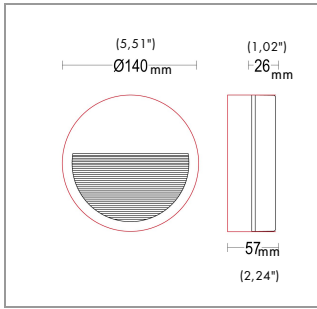
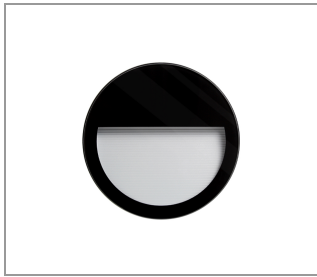



Light source	LED
Type of bulb or LED	LED
Light source [W]	4 W
Nominal LED emission [Lm]	544 lm
Color temperature	3000 K
Color rendering index	CRI>90
Binning	Step MacAdam 3
Life Time LED [t]	60.000h - L80 - B10
LED voltage range [V]	6V
Current	350 mA
Luminaire emission [lm]	1 x 128
LED / Bulb	Included



LIGHTING SOURCE for model GH1360.BGXP400EN

Light source	LED
Type of bulb or LED	LED
Light source [W] Nominal	4 W
LED emission [lm] Color temperature	576 lm 4000 K
Color rendering index	CRI>90
Binning	Step MacAdam 3
Life Time LED [t]	60.000h - L80 - B10
LED voltage range [V]	6V
Current	350 mA
Luminaire emission [lm]	1 x 136
LED / Bulb	Included

FINISH CODE:

-  .05 Dark Grey (matt)
-  .19 Light Grey
-  .80 Sand
-  .01 White (matt)
-  .02 Black (matt)
-  .15 Stainless Steel
-  .45 Corten

ACCESSORIES:



Rough-in housing Miniverso Flat
rd r
AC265



Extraction tool for recessed
version Flat
AC264

