

CONSTRUCTIVE & DIMENSIONAL:

Application field:	Series of recessed lighting fixtures characterized by the reduced recess depth of only 50mm.
Construction material:	Die-cast aluminum EN AB 44100 highly resistant to oxidation
External screws:	Stainless steel A4-70 treated with highly antioxidant water-repellent lubricating solution
Gaskets:	Silicone gaskets
Diameter [mm]:	220mm(8,66")
Height / Projection [mm]:	26mm(1,02")
Cutout shape:	Round
Cutout diameter [mm]:	223mm(8,77")
Recessed depth [mm]:	57mm(2,24")
Rough in housing:	Stainless steel AISI 430 - to be ordered separately

ELECTRICAL:

Description and Model Code:	GH1361.CAXP300EN	1 x 8.7 W LED 3000 K CRI>90 1 x 1101 l
	GH1361.CAXP300EN	1 x 8.7 W LED 4000 K CRI>90 1 x 1167 lm
Operating Power:	110-277 V / 50-60 Hz	
Number of heads:	1	
Number of circuits:	1	
Driver positioning:	Integral	
Luminaire efficiency [lm/W]:	28.59 for model GH1361.CAXP300EN 30.31 for model GH1361.CAXP300EN	
Fixture consumption:	10.24 W	
Control gear type:	Electronic	
Dimmer type:	Not dimmable	
Cable entry:	IP66 lamellar bushing Ø max 9mm	
Daisy chain wiring:	External to the luminaire with IP68 connector available as an accessory	
Emergency:	Not available	
Ambient temperature operating range [°C]:	-20 °C ÷ +35 °C	

OPTICAL:

Beam angle [°]	38° x 78°
Light distribution	Other
Beam directionability	Fixed optics
Diffuser material	Sodium-calcium tempered glass 3mm
Diffuser finish	Micro-prism
Diffuser temperature [°C]	< 30 °C / 86 °F

LIGHTING SOURCE for model GH1361.CAXP300EN



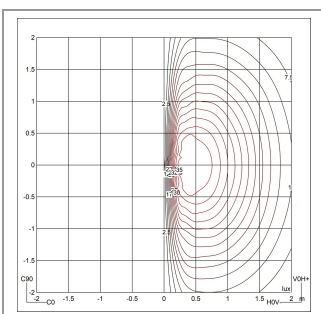
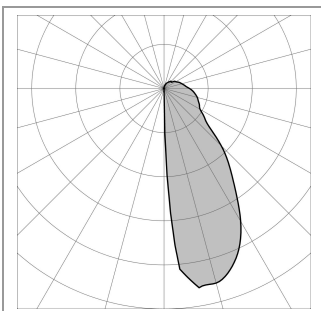
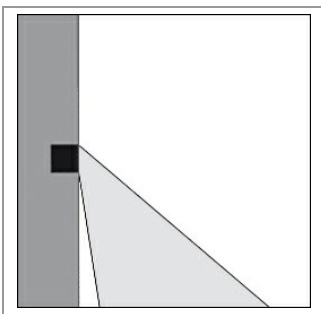
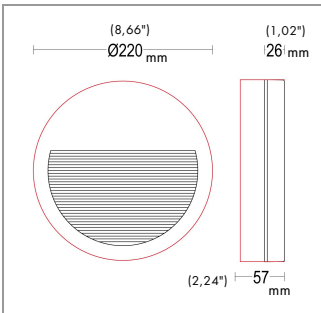
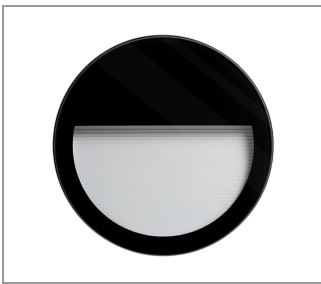



Light source	LED
Type of bulb or LED	LED
Light source [W]	8.7 W
Nominal LED emission [Lm]	1101 lm
Color temperature	3000 K
Color rendering index	CRI>90
Binning	Step MacAdam 3
Life Time LED [t]	60.000h - L80 - B10
LED voltage range [V]	6V
Current	500 mA
Luminaire emission [lm]	1 x 293
LED / Bulb	Included



LIGHTING SOURCE for model GH1361.CAXP400EN

Light source	LED
Type of bulb or LED	LED
Light source [W]	8.7 W
Nominal LED emission [Lm]	1167 lm
Color temperature	4000 K
Color rendering index	CRI>90
Binning	Step MacAdam 3
Life Time LED [t]	60.000h - L80 - B10
LED voltage range [V]	6V
Courrent	500 mA
Luminaire emission [lm]	1 x 310
LED / Bulb	Included

FINISH CODE:

-  .05 Dark Grey (matt)
-  .19 Light Grey
-  .80 Sand
-  .01 White (matt)
-  .02 Black (matt)
-  .15 Stainless Steel
-  .45 Corten

ACCESSORIES:



Rough-in housing Miniverso Flat
rd r
AC265



Extraction tool for recessed
version Flat
AC264

