

CONSTRUCTIVE & DIMENSIONAL:

| | |
|---------------------------|---|
| Application field: | Series of spot lights to be mounted on floor, wall, spike, tree with belt or on a pole system |
| Construction material: | Extruded aluminum EN AW-6060 T5 high resistance to oxidation, Die-cast aluminum EN AB 44100 highly resistant to oxidation |
| External screws: | Stainless steel A4-70 treated with highly antioxidant water-repellent lubricating solution |
| Gaskets: | Silicone gaskets |
| Length [mm]: | 200mm(7,87") |
| Width [mm]: | 200mm(7,87") |
| Height / Projection [mm]: | 332mm(13,07") |

ELECTRICAL:

| | | | |
|-----------------------------|------------------|------------------------------|-------------|
| Description and Model Code: | GH1107.FLMT300EN | 1 x 42 W LED 3000 K CRI>90 | 1 x 5129 lm |
| | GH1107.FLM.T | | |
| | GH1107.FLMT400EN | 1 x 42 W LED 4000 K CRI>90 | 1 x 5207 lm |
| | GH1107.FMM.T | | |
| | GH1107.ECMT300EN | 1 x 32 W LED 3000 K CRI>90 | 1 x 3957 lm |
| | GH1107.ECM.T | | |
| | GH1107.ECMT400EN | 1 x 32 W LED 4000 K CRI>90 | 1 x 4018 lm |
| | GH1107.EDM.T | | |
| | GH1107.CGMT300EN | 1 x 24.5 W LED 3000 K CRI>90 | 1 x 3116 lm |
| | GH1107.CDM.T | | |
| | GH1107.CGMT400EN | 1 x 24.5 W LED 4000 K CRI>90 | 1 x 3164 lm |
| | GH1107.CEM.T | | |

| | |
|---|---|
| Operating Power: | 110-277 V / 50-60 Hz |
| Number of heads: | 1 |
| Number of circuits: | 1 |
| Driver positioning: | Integral |
| Control gear type: | Electronic |
| Cable entry: | Metal cable gland M20 Ø 7/13 mm |
| Luminaire efficiency [lm/W]: | 77.84 for model GH1107.FLMT300EN GH1107.FLM.T |
| | 79.02 for model GH1107.FLMT400EN GH1107.FMM.T |
| | 78.82 for model GH1107.ECMT300EN GH1107.ECM.T |
| | 80.03 for model GH1107.ECMT400EN GH1107.EDM.T |
| | 81.06 for model GH1107.CGMT300EN GH1107.CDM.T |
| | 82.31 for model GH1107.CGMT400EN GH1107.CEM.T |
| | 47.73 W for model GH1107.FLMT300EN GH1107.FLM.T |
| | 47.73 W for model GH1107.FLMT400EN GH1107.FMM.T |
| Fixture consumption: | 36.36 W for model GH1107.ECMT300EN GH1107.ECM.T |
| | 36.36 W for model GH1107.ECMT400EN GH1107.EDM.T |
| | 27.84 W for model GH1107.CGMT300EN GH1107.CDM.T |
| | 27.84 W for model GH1107.CGMT400EN GH1107.CEM.T |
| Dimmer type: | Dimmable upon request |
| Daisy chain wiring: | External to the luminaire with IP68 connector available as an accessory |
| Cable type: | H07RN8-F 3x1mm2 |
| Cord length [m]: | 0.5 |
| Emergency: | Not available |
| Ambient temperature operating range [°C]: | -20 °C ÷ +35 °C |

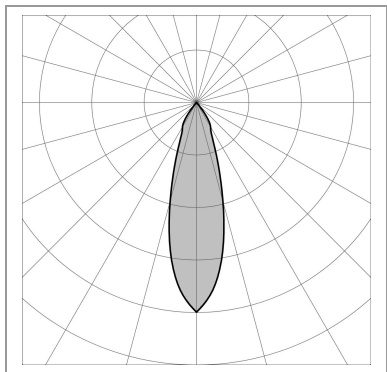
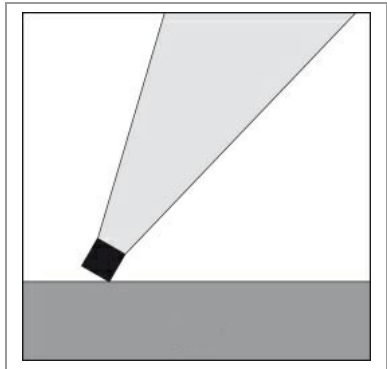
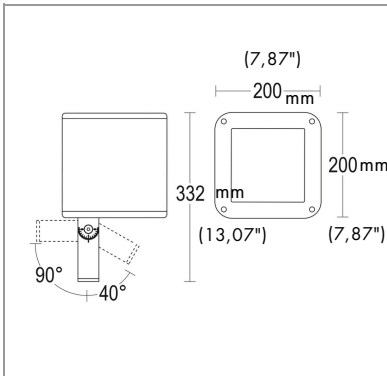

| H(m) | φ(m) | lux med. 3000 K | lux max. 3000 K |
|------|------|--------------------|--------------------|
| 5 | 2.6 | 249 | 410 |
| 4 | 2.1 | 389 | 640 |
| 3 | 1.6 | 691 | 1138 |
| 2 | 1.1 | 1555 | 2560 |
| 1 | 0.5 | 6222 | 10241 |

GH1107.FLMT300EN

GH1107.FLM.T

| H(m) | φ(m) | lux med. 4000 K | lux max. 4000 K |
|------|------|--------------------|--------------------|
| 5 | 2.6 | 253 | 416 |
| 4 | 2.1 | 395 | 650 |
| 3 | 1.6 | 702 | 1155 |
| 2 | 1.1 | 1579 | 2599 |
| 1 | 0.5 | 6316 | 10397 |

GH1107.FLMT400EN

GH1107.FMM.T

| H(m) | φ(m) | lux med. 3000 K | lux max. 3000 K |
|------|------|--------------------|--------------------|
| 5 | 2.6 | 192 | 316 |
| 4 | 2.1 | 300 | 494 |
| 3 | 1.6 | 533 | 878 |
| 2 | 1.1 | 1200 | 1975 |
| 1 | 0.5 | 4800 | 7901 |







GH1107.ECMT300EN

GH1107.ECM.T

OPTICAL:

| | |
|-----------------------|---|
| Beam angle [°] | 29° |
| Light distribution | Symmetrical medium flood (15° - 45°) |
| Beam directionability | Adjustable |
| Swivel [°] | 40° - 90° |
| Diffuser material | Sodium-calcium tempered glass 6mm |
| Diffuser finish | Transparent - extra clear |
| Optics | Aluminum reflector with super pure aluminum metallization |

FINISH CODE:

| | | |
|--|--|--|
|  .05 Dark Grey (matt) |  .19 Light Grey |  .80 Sand |
|  .01 White (matt) |  .02 Black (matt) |  .45 Corten |

LIGHTING SOURCE for model GH1107.FLMT300EN GH1107.FLM.T

| | |
|---------------------------|----------------|
| Light source | LED |
| Type of bulb or LED | LED |
| Light source [W] | 42 W |
| Nominal LED emission [Lm] | 5129 lm |
| Color temperature | 3000 K |
| Color rendering index | CRI>90 |
| Binning | Step MacAdam 3 |
| LED voltage range [V] | 31.2-36.8V |
| Current | 1200 mA |
| Luminaire emission [lm] | 1 x 3715 |
| LED / Bulb | Included |

LIGHTING SOURCE for model GH1107.FLMT400EN GH1107.FMM.T

| | |
|---------------------------|----------------------|
| Light source | LED |
| Type of bulb or LED | LED |
| Light source [W] | 42 W |
| Nominal LED emission [Lm] | 5207 lm |
| Color temperature | 4000 K |
| Color rendering index | CRI>90 |
| Life Time LED [t] | 100.000h - L80 - B10 |
| LED voltage range [V] | 31.2-36.8V |
| Current | 1600 mA |
| Luminaire emission [lm] | 1 x 3771 |
| LED / Bulb | Included |

LIGHTING SOURCE for model GH1107.ECMT300EN GH1107.ECM.T

| | |
|---------------------------|----------------------|
| Light source | LED |
| Type of bulb or LED | LED |
| Light source [W] | 32 W |
| Nominal LED emission [Lm] | 3957 lm |
| Color temperature | 3000 K |
| Color rendering index | CRI>90 |
| Binning | Step MacAdam 3 |
| Life Time LED [t] | 100.000h - L80 - B10 |
| LED voltage range [V] | 31.2-36.8V |
| Current | 900 mA |
| Luminaire emission [lm] | 1 x 2866 |
| LED / Bulb | Included |

LIGHTING SOURCE for model GH1107.ECMT400EN GH1107.EDM.T

| H(m) | φ(m) | lux med. 4000 K | lux max. 4000 K |
|------|------|--------------------|--------------------|
| 5 | 2.6 | 195 | 321 |
| 4 | 2.1 | 305 | 501 |
| 3 | 1.6 | 542 | 891 |
| 2 | 1.1 | 1219 | 2006 |
| 1 | 0.5 | 4874 | 8023 |

GH1107.ECMT400EN
GH1107.EDM.T

| | |
|---------------------------|----------------------|
| Light source | LED |
| Type of bulb or LED | LED |
| Light source [W] | 32 W |
| Nominal LED emission [Lm] | 4018 lm |
| Color temperature | 4000 K |
| Color rendering index | CRI>90 |
| Binning | Step MacAdam 3 |
| Life Time LED [t] | 100.000h - L80 - B10 |
| LED voltage range [V] | 31.2-36.8V |
| Courrent | 900 mA |
| Luminaire emission [lm] | 1 x 2910 |
| LED / Bulb | Included |

LIGHTING SOURCE for model GH1107.CGMT300EN GH1107.CDM.T

| H(m) | φ(m) | lux med. 3000 K | lux max. 3000 K |
|------|------|--------------------|--------------------|
| 5 | 2.6 | 151 | 249 |
| 4 | 2.1 | 236 | 389 |
| 3 | 1.6 | 420 | 691 |
| 2 | 1.1 | 945 | 1555 |
| 1 | 0.5 | 3780 | 6222 |

GH1107.CGMT300EN
GH1107.CDM.T

| | |
|---------------------------|----------------------|
| Light source | LED |
| Type of bulb or LED | LED |
| Light source [W] | 24.5 W |
| Nominal LED emission [Lm] | 3116 lm |
| Color temperature | 3000 K |
| Color rendering index | CRI>90 |
| Binning | Step MacAdam 3 |
| Life Time LED [t] | 100.000h - L80 - B10 |
| LED voltage range [V] | 31.2-36.8V |
| Courrent | 700 mA |
| Luminaire emission [lm] | 1 x 2257 |
| LED / Bulb | Included |

LIGHTINGSOURCE for model GH1107.CGMT400EN GH1107.CEM.T

| H(m) | φ(m) | lux med. 4000 K | lux max. 4000 K |
|------|------|--------------------|--------------------|
| 5 | 2.6 | 154 | 253 |
| 4 | 2.1 | 240 | 395 |
| 3 | 1.6 | 426 | 702 |
| 2 | 1.1 | 960 | 1579 |
| 1 | 0.5 | 3838 | 6318 |

GH1107.CGMT400EN
GH1107.CEM.T

| | |
|---------------------------|----------------------|
| Light source | LED |
| Type of bulb or LED | LED |
| Light source [W] | 24.5 W |
| Nominal LED emission [Lm] | 3164 lm |
| Color temperature | 4000 K |
| Color rendering index | CRI>90 |
| Binning | Step MacAdam 3 |
| Life Time LED [t] | 100.000h - L80 - B10 |
| LED voltage range [V] | 31.2-36.8V |
| Courrent | 700 mA |
| Luminaire emission [lm] | 1 x 2292 |
| LED / Bulb | Included |

ACCESSORIES:

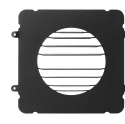

Stake 220mm
AC711

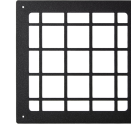

Antiglare louver Faro
AC180

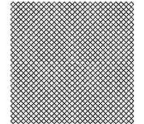

Vandal proof grid Faro
AC181



Microprismatic lens Faro
AC182

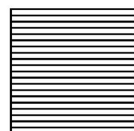

Elipsoidal lens Faro
AC184



Directional flaps Faro
AC185



Tree fixing strap - Faro
AC643