

Floor lamp  
 Year of production: 2000  
 Versions: lighting.  
 Material: Polyethylene.  
 Black color: Black  
 Dimensions: Ø 120cm(47.24") h 60cm(23.62")  
 Weight: 22 Kg  
 Packaging: 121 x 121 x 77 cm  
 Packaging volume: 1,127 m3

DIMENSIONS (cm)	
CODE	LP MSF121 lighting OUT                       MATT FINISH
LIGHTING	1x           Energy saving bulb recommended (not included).
COLOURS	LIGHTING <input type="radio"/> LIGHT WHITE (code LA)

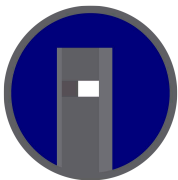

DIMENSIONS (cm) - CODE - COLOURS

### EARTH SPIKE

Material: plastic ABS

Weight: 0,1 Kg

Note: not included.

LP TUB002

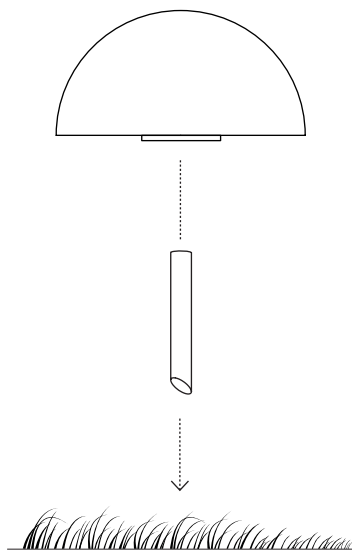

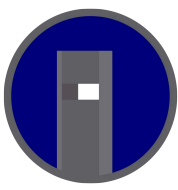

# BULLARD BOLLARDS

## SYMBOLS



For indoor use.



Stackable item.



For indoor and outdoor use.



100% recyclable polyethylene.



Outdoor version on request (IP55).



European Community registered model.

## LIGHTING SYMBOLS



Protected against the intrusion of solid objects  $\varnothing > 12$  mm, not against water.



Lamp base for G4 halogen bulb.



RGB lighting system.



Protected against the intrusion of solid objects  $\varnothing > 1$  mm and splashing water.



Lamp base for GU10 spotlight.



Item compatible with Candy Light.



Protected against the intrusion of dust and water jets.



Lamp base for G13 neon tube. Neon



Insulation class 1.



Fully protected against the intrusion of dust and immersion in water.



tube lighting system.



Insulation class 2.



Small lamp base for E14 - 14 mm light bulb.



LED technology lighting system.



Insulation class 3.



Medium lamp base for E26 - 26 mm light bulb.



Device proper to direct assembly onto normally inflammable surfaces.

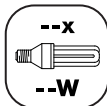

Lighting through energy saving bulb.  
The upper figure shows the number of allowed bulbs.  
The lower figure shows the MAXIMUM recommended power.

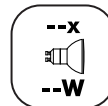

Lighting through energy saving fluorescent spotlight.  
The upper figure shows the number of allowed spotlights.  
The lower figure shows the MAXIMUM recommended power.

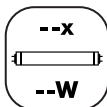

Lighting through neon tube.  
The upper figure shows the number of allowed neon tubes.  
The lower figure shows the MAXIMUM recommended power.

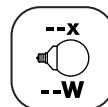

Lighting through energy saving globe bulb.  
The upper figure shows the number of allowed bulbs.  
The lower figure shows the MAXIMUM recommended power.



Lighting through flexible LED tube.  
The lower figure shows the MAXIMUM recommended power.



Lighting through circular T9 neon tube.  
The upper figure shows the number of allowed neon tubes.  
The lower figure shows the MAXIMUM recommended power.

## MATERIAL PROPERTIES

Material: Linear low-density polyethylene - LLDPE.

Production process: rotational moulding.

Resistant to extreme temperatures (-60°C to +80°C).

UV resistant (except for lighting colours).

High tensile strength.

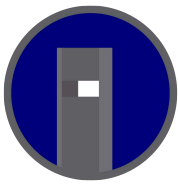

# BULLARD BOLLARDS

## WIRING SYMBOLS



**I1**  
Wiring with metal clamp.  
IP20 protection.  
Diameter 11 cm.

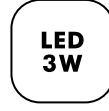

**LED  
3W**  
Wiring with special base for KIT LED 3 WATT.  
IP55 protection.  
Diameter 11,6 cm.



**E1  
SMALL**  
Wiring with metal base.  
IP55 protection.  
Diameter 10 cm. Fastening by hex screw key.



**E3/I3  
SMALL**  
Wiring with plastic screw base.  
I3 - IP20 protection. E3 - IP55 protection.  
Diameter 6 cm.



**E1  
LARGE**  
Wiring with metal base.  
IP55 protection.  
Diameter 20 cm. Fastening by hex screw key.



**E3/I3  
MEDIUM**  
Wiring with plastic screw base.  
I3 - IP20 protection. E3 - IP55 protection.  
Diameter 10 cm.

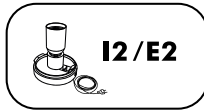

**I2 / E2**  
Wiring with plastic base and metal inserts.  
I2 - IP20 protection. E2 - IP55 protection.  
Diameter 10 cm. Fastening by slot screwdriver.



**E3/I3  
LARGE**  
Wiring with plastic screw base.  
I3 - IP20 protection. E3 - IP55 protection.  
Diameter 15 cm.



**CANDY  
LIGHT**  
Wiring with plastic base and LED CANDY LIGHT.  
IP44 protection.  
Diameter 10 cm.



**CUSTOM  
BASE**  
Special metal base.  
IP20 protection.  
Several sizes.