

Floor lamp

Year of production: 2000

Versions: lighting.

Material: Polyethylene.

Cable color: Black

Dimensions: Ø 40cm(15.74") h 20 cm(7.87")

Weight: 1,6 Kg

Packaging: 41 x 41 x 24 cm

Packaging volume: 0,04 m3

DIMENSIONS (cm)	
CODE	<p>LP MSF041 lighting OUT</p> <p>MATT FINISH</p>
LIGHTING	<p>1x E3/13 MEDIUM</p> <p>1x 15W Energy saving bulb recommended (not included).</p>
COLOURS	<p>LIGHTING</p> <p><input type="radio"/> LIGHT WHITE (code LA)</p> <p>LED VERSION</p> <p><input type="radio"/> LIGHT WHITE (code LA)</p> <p>KIT LED 3W RGB MULTICOLOUR (included). With battery charger and remote control (battery life 8hrs - charging time 10 hrs).</p>

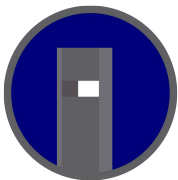

DIMENSIONS (cm) - CODE - COLOURS

EARTH SPIKE

Material: plastic ABS

Weight: 0,1 Kg





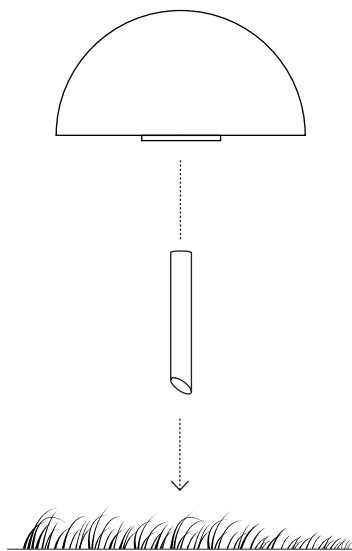
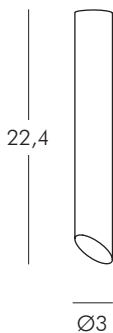

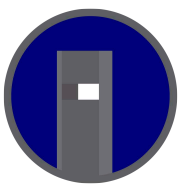
Note: not included.

LP TUB002























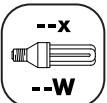

SYMBOLS

-  For indoor use.
-  Stackable item.
-  For indoor and outdoor use.
-  100% recyclable polyethylene.
-  Outdoor version on request (IP55).
-  European Community registered model.

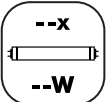
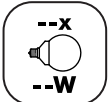
LIGHTING SYMBOLS

-  Protected against the intrusion of solid objects $\varnothing > 12$ mm, not against water.
-  Lamp base for G4 halogen bulb.
-  RGB lighting system.
-  Protected against the intrusion of solid objects $\varnothing > 1$ mm and splashing water.
-  Lamp base for GU10 spotlight.
-  Item compatible with Candy Light.
-  Protected against the intrusion of dust and water jets.
-  Lamp base for G13 neon tube. Neon
-  Insulation class 1.
-  Fully protected against the intrusion of dust and immersion in water.
-  tube lighting system.
-  Insulation class 2.
-  Small lamp base for E14 - 14 mm light bulb.
-  LED technology lighting system.
-  Insulation class 3.
-  Medium lamp base for E26 - 26 mm light bulb.
-  Device proper to direct assembly onto normally inflammable surfaces.
-  Lighting through energy saving bulb.
The upper figure shows the number of allowed bulbs.
The lower figure shows the MAXIMUM recommended power.
-  Lighting through energy saving fluorescent spotlight.
The upper figure shows the number of allowed spotlights.
The lower figure shows the MAXIMUM recommended power.
-  Lighting through neon tube.
The upper figure shows the number of allowed neon tubes.
The lower figure shows the MAXIMUM recommended power.
-  Lighting through energy saving globe bulb.
The upper figure shows the number of allowed bulbs.
The lower figure shows the MAXIMUM recommended power.
-  Lighting through flexible LED tube.
The lower figure shows the MAXIMUM recommended power.
-  Lighting through circular T9 neon tube.
The upper figure shows the number of allowed neon tubes.
The lower figure shows the MAXIMUM recommended power.

MATERIAL PROPERTIES

Material: Linear low-density polyethylene - LLDPE.
 Production process: rotational moulding.
 Resistant to extreme temperatures (-60°C to +80°C).
 UV resistant (except for lighting colours).
 High tensile strength.

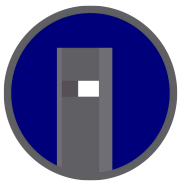

BULLARD BOLLARDS

WIRING SYMBOLS



I1
Wiring with metal clamp.
IP20 protection.
Diameter 11 cm.

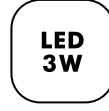

**LED
3W**
Wiring with special base for KIT LED 3 WATT.
IP55 protection.
Diameter 11,6 cm.



**E1
SMALL**
Wiring with metal base.
IP55 protection.
Diameter 10 cm. Fastening by hex screw key.



**E3/I3
SMALL**
Wiring with plastic screw base.
I3 - IP20 protection. E3 - IP55 protection.
Diameter 6 cm.



**E1
LARGE**
Wiring with metal base.
IP55 protection.
Diameter 20 cm. Fastening by hex screw key.



**E3/I3
MEDIUM**
Wiring with plastic screw base.
I3 - IP20 protection. E3 - IP55 protection.
Diameter 10 cm.

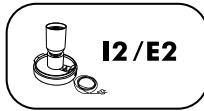

I2 / E2
Wiring with plastic base and metal inserts.
I2 - IP20 protection. E2 - IP55 protection.
Diameter 10 cm. Fastening by slot screwdriver.



**E3/I3
LARGE**
Wiring with plastic screw base.
I3 - IP20 protection. E3 - IP55 protection.
Diameter 15 cm.



**CANDY
LIGHT**
Wiring with plastic base and LED CANDY LIGHT.
IP44 protection.
Diameter 10 cm.



**CUSTOM
BASE**
Special metal base.
IP20 protection.
Several sizes.