

## EDGE C 3-5-10L IP20

















**(EN) WARNING:**

- The safety of this fixture is guaranteed only if you comply with these instructions; remember to keep in a safe place.
- The appliance must not be tampered with or transformed and it must be installed and used as supplied and in compliance with the national rules on installations.
- Switch-off the power supply before carrying out any maintenance operations. hot plug-in is not allow and may cause damage to the luminaire.
- The light source contained in this luminaire shall be replaced only by the manufacturer or his service agent.
- Installation and service must be performed by qualified service personnel.
- Use the unit only complete with diffuser.
- Any non-compliant installations will invalidate all forms of guarantee.

DEGREE OF PROTECTION	IMPACT RESISTANCE
IK00	No protection
IK01	up to 0,150 J
IK02	up to 0,200 J
IK03	up to 0,350 J
IK04	up to 0,500 J
IK05	up to 0,700 J
IK06	up to 1,00 J
IK07	up to 2,00 J
IK08	up to 5,00 J
IK09	up to 10,00 J
IK10	up to 20,00 J

IP RATING	DEFINITION
IP 44	<p>Protection against the penetration of solid bodies greater than 1 mm.</p> <p>Protection against the penetration of liquids by drops, vapors or spray in any direction.</p> <p>The penetration of solid bodies of less than 1 mm and liquids must not damage the equipment.</p>
IP 54	<p>Total protection against the penetration of solid bodies.</p> <p>Protection against the penetration of liquids by drops, vapors or splashes in any direction.</p> <p>The penetration of dust and liquids must not damage the equipment.</p>
IP 65	<p>Protezione totale alla penetrazione di corpi solidi e polveri./ Total protection against the penetration of solid bodies and dust.</p> <p>Protezione contro la penetrazione di liquidi da gocce, vapori, spruzzi e getti d'acqua in qualsiasi direzione./ Protection against the penetration of liquids by drops, vapors, splashes and jets of water in any direction.</p> <p>La penetrazione liquidi non deve danneggiare l'apparecchiatura./ Liquid penetration must not damage the equipment.</p>
IP 66	<p>Total protection against the penetration of solid bodies and dust.</p> <p>Protection against the penetration of liquids from splashes, storm surges and strong jets of water in any direction.</p> <p>Liquid penetration must not damage the equipment.</p>
IP 67	<p>Total protection against the penetration of solid bodies and dust.</p> <p>Protection against momentary immersion in water for 30 minutes at a depth of 1 meter.</p>
IP 68	<p>Total protection against the penetration of solid bodies and dust.</p> <p>Protection against permanent immersion in water at a depth of 1 meter.</p>

	Class I appliance.
	Class II appliance.
	Class IIIw appliance.
	Photobiological risk, the possibility that light causes damage to the human eye.
	Replace damaged shields.
	Min. distance from the light fixture.
	Waste of electrical and electronic equipment.
	Waterlock system.
	the product is suitable for vehicles.
	Maxi-mum weight supported by the product.
	Human touch.
	Disconnect the power supply before carrying out any type of maintenance.
	Periodic cleaning and maintenance.
	Very low voltage.
	Warning!

For more information on the luminaire consult the technical data sheet

### EDGE C 3L 100

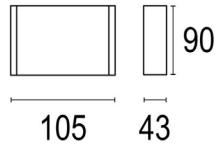

### EDGE C 5L 150

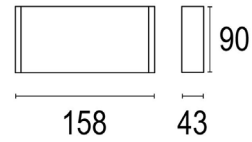

### EDGE C 10L 300

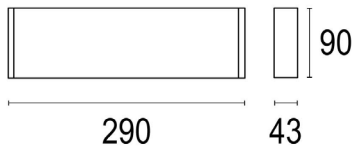

## Switch-off the power supply

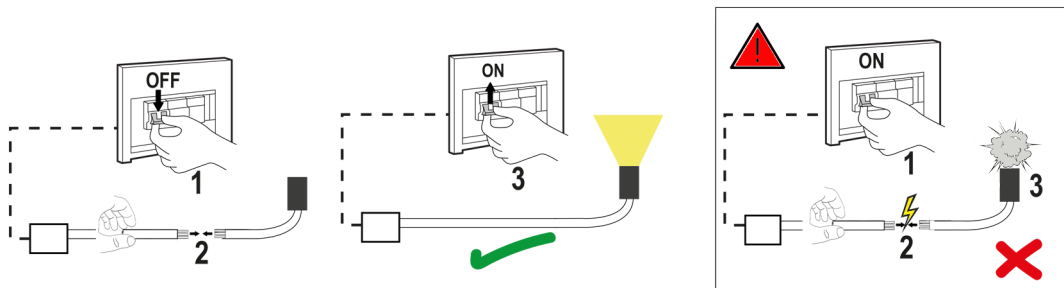

# INSTALLATION HOLE

Use for:  
Edge C 3L 100

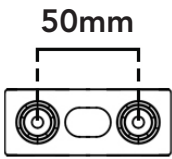

Use for:  
Edge C 5L 150  
Edge C 10L 300

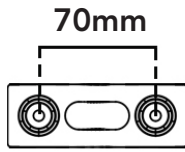

1

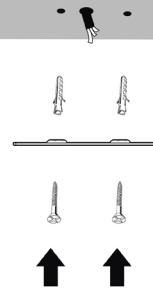

2

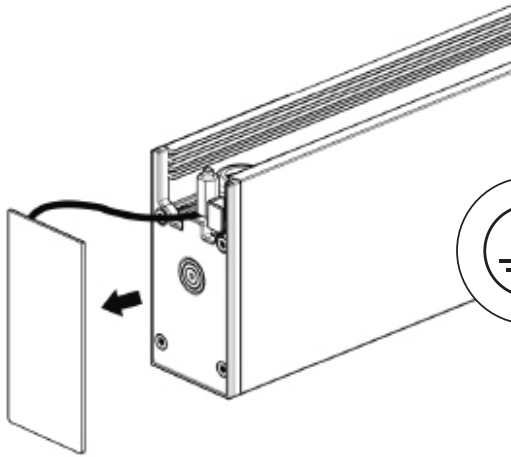

# STANDARD CONNECTION

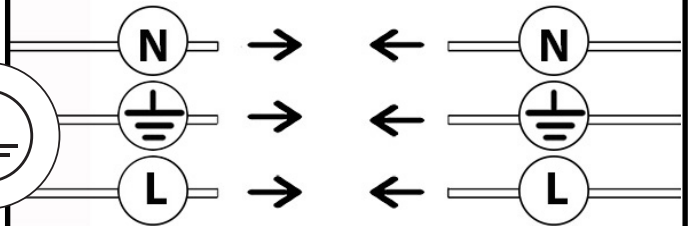

⚠ MIN IP 66 CONNECTION

# 1-10V CONNECTION

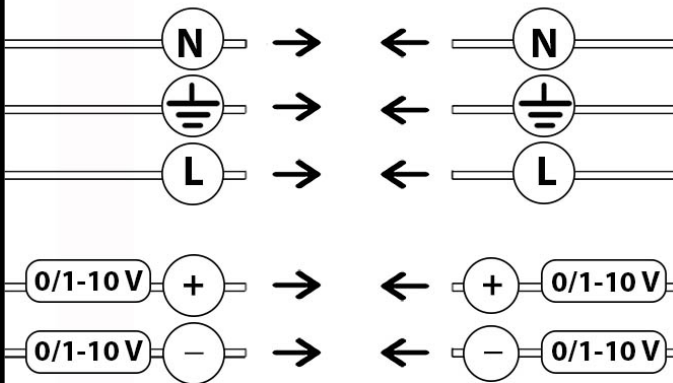

⚠ MIN IP 66 CONNECTION

# DALI CONNECTION

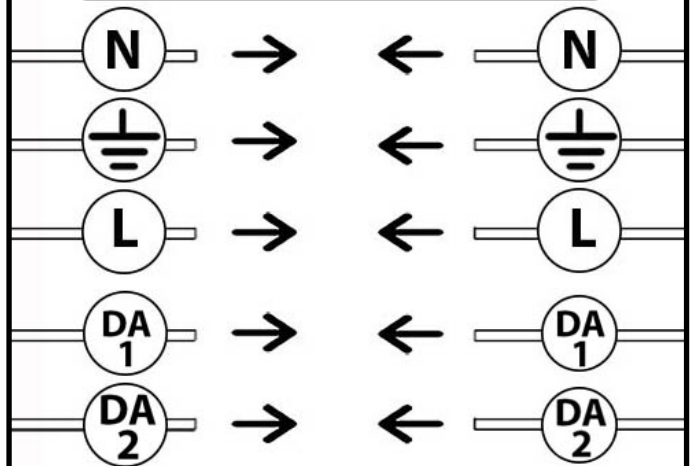

⚠ MIN IP 66 CONNECTION

sales@gordonbullard.com  
www.bullardbollards.com  
1-877-964-4646



991 South Gull Lake  
Dr Richland, MI  
49083 USA

# CLASS 3

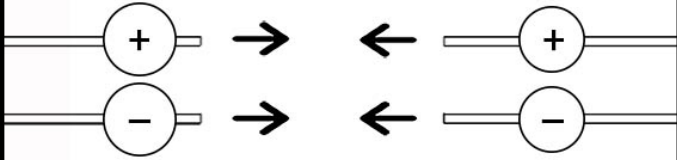

REMOTE DRIVER

⚠ MIN IP 66 CONNECTION

3

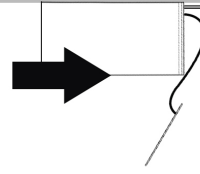
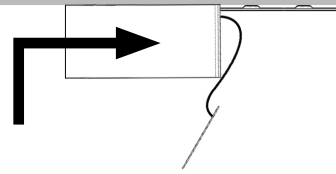

4

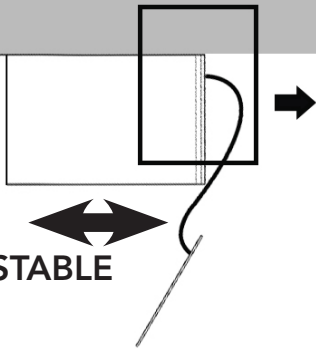

ADJUSTABLE

Screw to fix the product to the ceiling

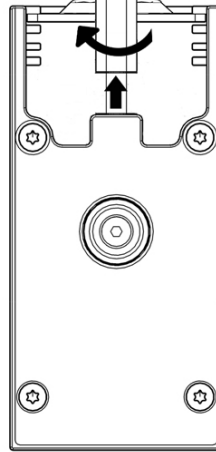

5

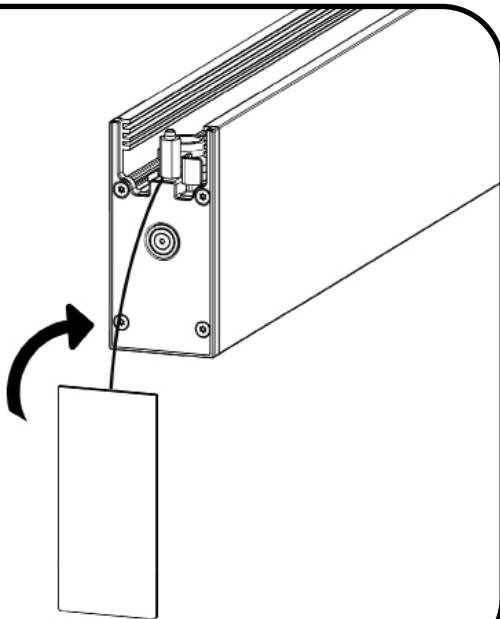



**EN** - In respect and compliance to environmental standards at the end of life do not dispose of as standard waste, this must be taken to one of the authorized collection points.

---

[sales@gordonbullard.com](mailto:sales@gordonbullard.com)  
[www.bullardbollards.com](http://www.bullardbollards.com)  
1-877-964-4646



991 South Gull Lake  
Dr Richland, MI  
49083 USA