

**BULLARD
BOLLARDS**
POWERED BY
SOLUX

AOSPRO 20

INTEGRATED SOLAR STREET LIGHT

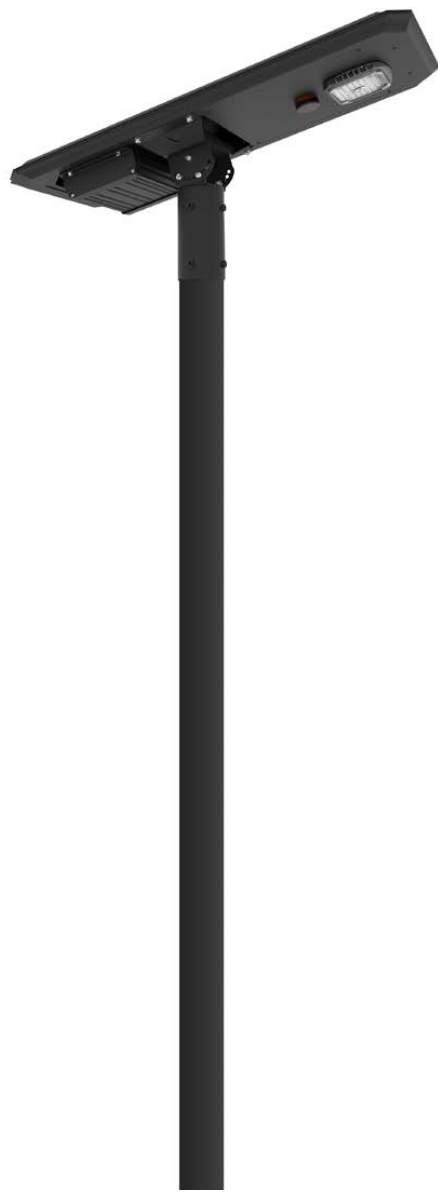

AOSPRO is a fully integrated solar street light system with all the components together in one single unit. The AOSPRO series is extremely simple to install and operate, making it **the ultimate solution for area lighting with motion sensors.**

NOMINAL FLUX **3920 LUMENS**
NOMINAL POWER **20 WATTS**

LIGHTING

Efficiency **196 Lumens/Watts**
Chips LED **PHILIPS Luxeon 30-30 / 2300K to 6500K**
LED lifetime **Over 80 000 hours LM80**
Optics/CCT **TII-S / 2300 to 6500K**
Light Height **From 3 to 4 meters (118,11" - 157,48")**

BATTERY

Technology **Lithium Iron Phosphate LIFEPO4**
Capacity **230 Wh**
Autonomy **Over 24 hours at full charge - 4 Rainy Days back up**
Charging time **5-6 hours**
Lifespan **Over 3000 CYCLES @ 80% DOD over 10 years Lifetime**
Working temp. **14°F to 158°F (optional -40°F to 158°F) -10°C to 70°C - (optional -40°C To 70°C)**

ENERGY

Solar panel **60 Watts /18V**
Cells type **Monocrystalline Panel Grade A 25 years**
Certificates **IEC 61215 - IEC 61730 I and II - IEC 60904**

ELECTRONIC

Controller **MPPT SMART CONTROLLER (SOLUX BRIDGE optional)**
Sensor **Microwave 360° Motion Sensor**
Cabling **Waterproof Connector, Plug and Play**
Protection **Battery Management System (BMS)**

MECHANICAL

Pole mounting **89mm - 76mm (3,50" x 3,00")**
Material **Aluminium and Stainless Steel**

DIMENSIONS

Product **910mm x 398mm x 343mm (35,83" x 15,67" x 13,50")**
Carton size **980mm x 460mm x 260mm (38,58" x 18,11" x 10,24")**
Net Weight **11.5 KG (25.35 lb)**
Gross Weight **15 KG (33.07 lb)**
Qty /Ctn 20"/40" **240/505**
Product code **AP-20**

Solux retains the right to modify or change product specifications without prior notice, as part of our ongoing commitment to improvement



Bike Paths



Hiking Trails



Car Parks & Rest Areas



Main Roads



Pathways & Alleys



Campsites

CERTIFICATIONS

IEC / TUV / EMC / LM-79- 08 and LM-80 test standards / IK8 / IP65 / CE / ULOR



*** Solux offers a 5 Year Limited Warranty** for the AOSPRO-Series luminaire shall be free from defects in material and workmanship for up to five (5) years from date of shipment. This limited warranty covers all components when installed and operated according to Solux instructions. Fixture suitable for ambient temperature from -10° to 50°. PV Panels - 20 year performance warranty Controller & Batteries : 5 years

AOSPRO 20 - INTEGRATED SOLAR STREET LIGHT - Data Sheet / Page 1 of 6

sales@gordonbullard.com
www.bullardbollards.com
1-877-964-4646



991 South Gull Lake Dr
Richland, MI 49083
USA

LUMINAIRE HOUSING & LEDS

20 WATTS - 3920 LUMENS - 2300 TO 6500 K

High pressure die-cast low-copper aluminum. **Protection class (IP65)**. Solux uses a high quality Polyester Powder Coating from **AKZO NOBEL**. This powder coating provides an excellent salt and humidity resistance as well as ultra violet resistance for color retention for this product.

Our Luminaire is equipped with **PHILIPS LUXEON HE PLUS** High efficiency Chips offering and overall **196 Lumens per Watt efficacy**.

Our luminaire also complies with the **DARK SKY** requirement for light pollution with an **Upward lighting of 0,71%**



▶ LED	3030	LED QTY (PCS) 40	LENS (PCS) 4	CRI > 80
-------	-------------	-------------------------	---------------------	--------------------

IP65



AOSPRO OPTICS

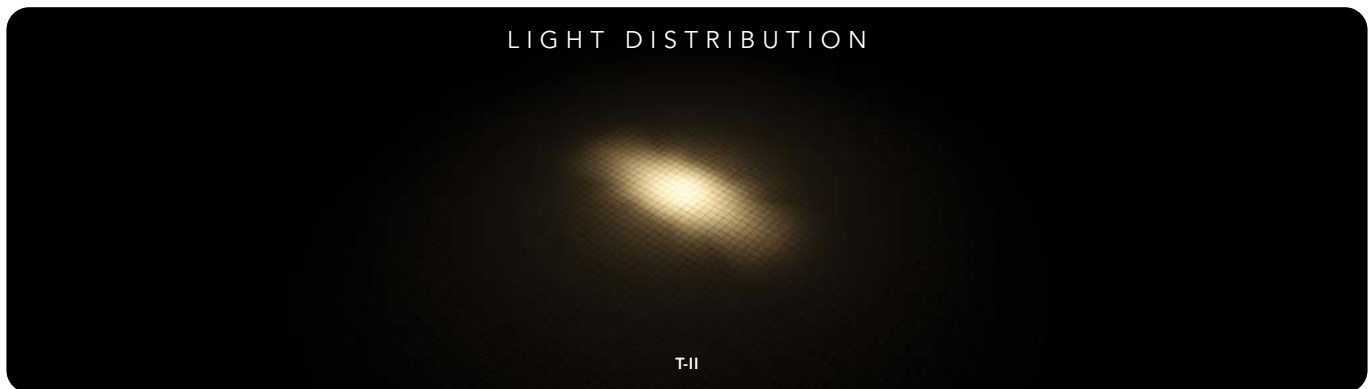

LIGHT DISTRIBUTION CURVES

AVERAGE BEAM ANGLE (50%) : **91,2 DEG**

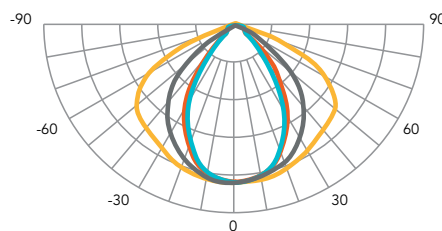

- C0/180,129.4°
- C60/240,72.7°
- C30/210,96.3°
- C90/270,66.4°



BATTERY LIFEPO4

+ OVER 10 YEARS LIFETIME



ALUMINUM WATERPROOF CASING & NATURAL AIRFLOW

High temperatures greatly negatively affect the battery's lifespan. This is why our batteries are **encapsulated in an aluminum waterproof casing** for a perfect heat dissipation.

In addition to that, the casing enjoys a natural airflow which **keeps the battery to ambient temperature.**

The AOSPRO Series is equipped with **Iron Phosphate Lithium LiFePo4** battery. This technology is proved to be **the best chemical technology for solar application on the market.**

With a cycle life of **over 3000 Cycles @ 80% DOD**, the battery enjoys over 10 years lifetime.

EXTREME TEMPERATURE

**14°F to 158°F (-40 °F OPTIONAL)
-10 °C TO 70 °C (-40 °C OPTIONAL)**

When Standard Lithium LiFePo4 batteries enjoy a working temperature range from 14°F to 158°F (-10°C TO 70 °C). Solux offers as **optional** a new Special LIFEPO4 battery with working range of -40°F to 158°F (-40 °C. to 70 °C).

EASY MAINTENANCE & ANTI THEFT SCREWS

Easy and direct access to the battery casing for maintenance. The fixation are made with anti theft screws, which request special tooling to unscrew.

BMS ELECTRONIC PROTECTION BATTERY MANAGEMENT SYSTEM

Our batteries are equipped with **electronic circuit boards for a higher protection**, ensuring battery functioning optimization no matter the situation.

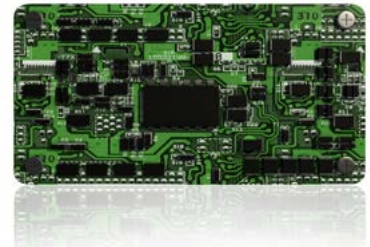

The BMS Protects against :

COMPARISONS OF DIFFERENT BATTERY TECHNOLOGIES

LIFETIME & CYCLES AT 80% DOD*

Comparisons of different battery technologies

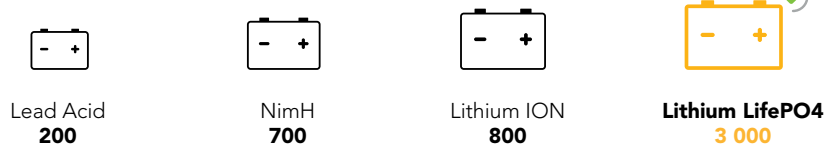

CHARGING TEMPERATURE RANGE WITHOUT CAPACITY LOSS

Minimum & Maximum temperature range for Optimal charging during the day

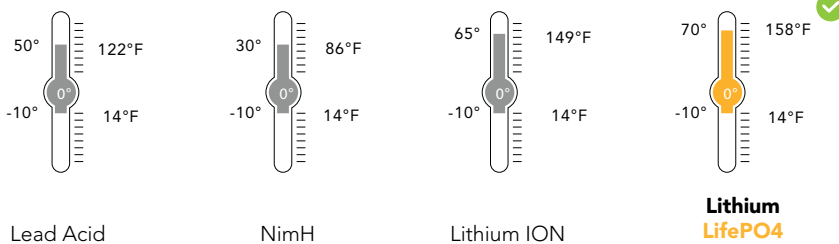

SOLAR PANEL

60 WATTS

High efficiency mono-crystalline **Solar panels**. Carefully selected **Grade A** Solar cells. Up to 19.4% efficiency.

Its **octagonal Anodized** aluminium alloy frame gives it a modern and elegant design as well as perfect resistance to corrosion. They are also equipped with fully **waterproof Plug and Play connectors**.

OUR PV PERFORMANCE GUARANTEE

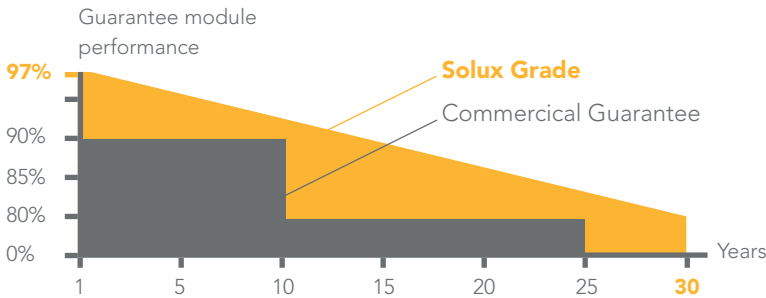

solar cells
GRADE A



CONTROLLER MPPT

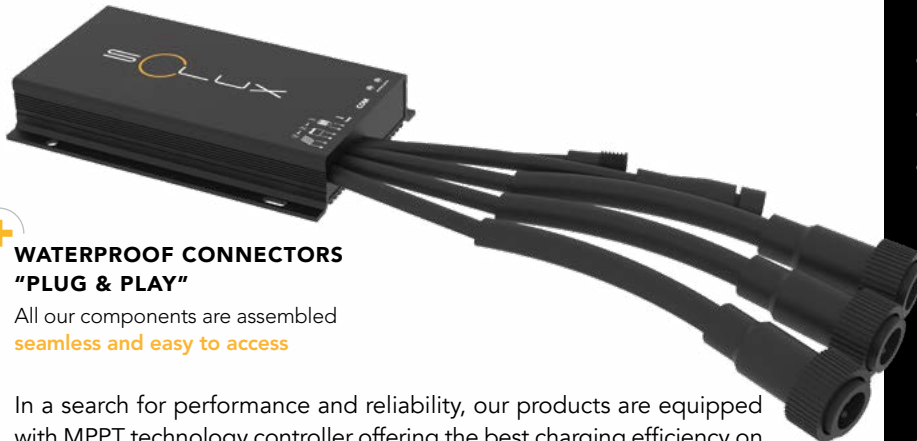

+ WATERPROOF CONNECTORS "PLUG & PLAY"

All our components are assembled **seamless and easy to access**

In a search for performance and reliability, our products are equipped with MPPT technology controller offering the best charging efficiency on the market up to 98%

REMOTE CONTROL MONITORING

In order to facilitate all maintenance operations and above all to diagnose any possible problem, without having to intervene mechanically on the luminaire, **Solux luminaires are equipped with a wireless diagnostic system via remote control**



With a simple click it is possible to have real-time information such as:

- Automatic diagnosis in case of malfunction
- State of charge and battery history
- Real Time load and solar panel energy production history
- Age of the product and installation
- Temperature and its history

F E A T U R E S

- Minimal stand-by power consumption
- Current consumption $\leq 10\text{mA}$
- Intelligent battery management
3 Phases charging :
 - Charge MPPT
 - Constant voltage
 - Floating voltage
- **Intelligent LED driver** Auto detecting of Dusk and Dawn for automatic operation, 7 Lighting Programs Configuration.
- **ANTI BLACK OUT :** Load adjust according to battery capacity assuring **all night long lighting in any weather conditions.**
- The controller also acts against:
 - OVERLOAD
 - OVERCURRENT
 - OVERTEMPERATURE
 - OVERVOLTAGE / OVERLOAD
 - OVERDISCHARGE

MOTION SENSOR MICROWAVE

Solux luminaires are equipped with microwave detectors that use the **Doppler effect** (like car radars) to detect a nearby objects and measure the distance. The sensor emits a high frequency wave to reflect off of and analyze the objects in the vicinity.

Since the microwaves **only detect specific objects**, detection reliability increases resulting in :

- Much better reliability compared to the Infrared detector
- Up to **360°** Directivity
- Insensitivity to **other environmental variations** such as light, color, temperature, etc.

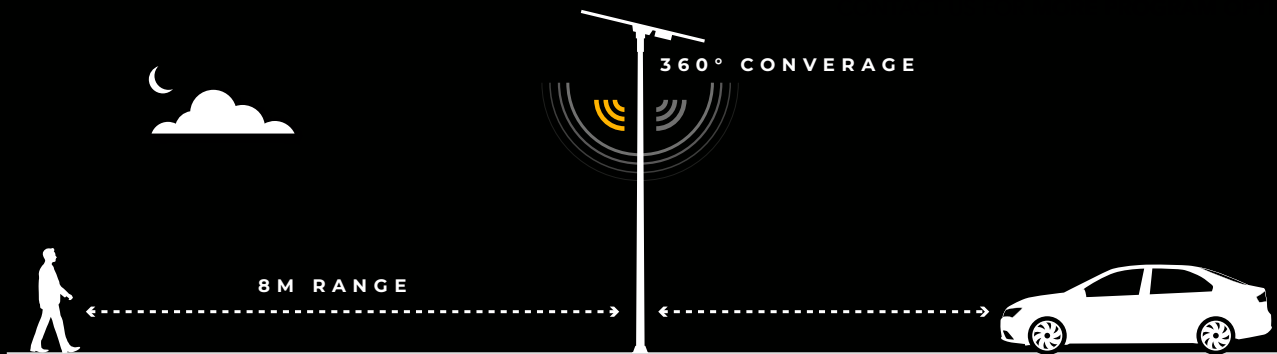

OPERATION MODE & LIGHTING SCHEDULE

In addition to automatic switching on and off , you have the possibility of choosing among **different modular operating modes** according to the needs of the project

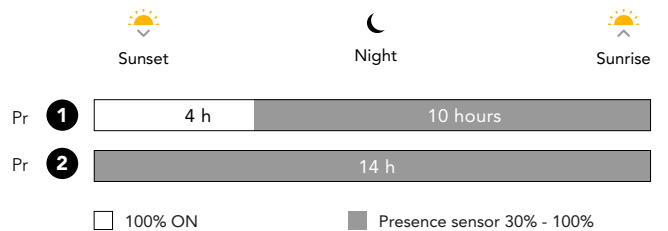

CONTACT US FOR **MORE PROGRAM OPTIONS**

EASY INSTALLATION

NO CABLING
NO TRENCHING

With a well designed bracket support AOSPRO is effortless and flexible to install.

INSERT, ORIENTATE & CHOOSE YOUR TILT



DIMENSIONS*

SOLAR PANEL & LED

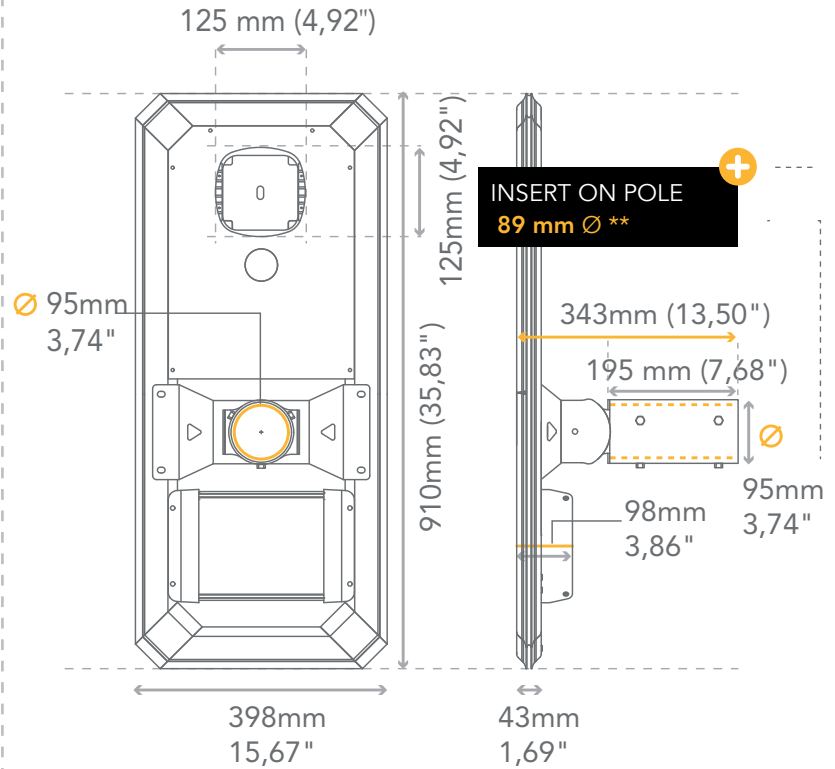
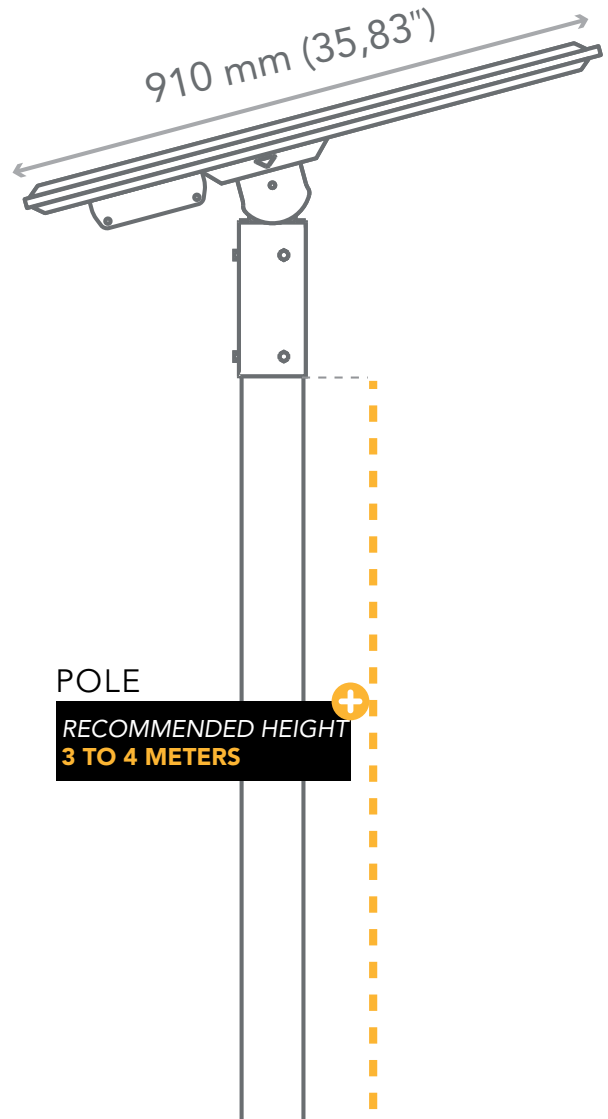

*All dimensions are in mm

** Available in 76mm Ø

AOSPRO 20 - INTEGRATED SOLAR STREET LIGHT - Data Sheet / Page 6 of 6

sales@gordonbullard.com
www.bullardbollards.com
1-877-964-4646



991 South Gull Lake Dr
Richland, MI 49083
USA

Due to the dynamic nature of lighting products and the associated technologies, luminaire data on all sheet sheets is subject to change at the discretion of Gordon Bullard LLC and associated companies.

© Bullard & Company 2023 All Rights Reserved

Updated 10/21/23